



TEST EQUIPMENT

**Radio
and Television**

CATALOG NO. 105



PARTS AND ACCESSORIES

WHITE ELECTRIC COMPANY

903 W. PIKE STREET ★ CLARKSBURG, W. VIRGINIA

PHONE 390

THE RIDER VoltOhmyst

PUSH-PULL ELECTRONIC VOLTMETER-OHMMETER

**0.05—5,000 Volts D.C.,
in 9 Ranges**

**0.1 ohm—1,000
Megohms in 7 Ranges**

Net Price

\$57⁵⁰

Stock No. 163

The Rider VoltOhmyst is a radically new Push-Pull Electronic D-C Voltmeter-Ohmmeter having extremely wide ranges. Ten billion to one is the ratio of its resistance range! This is wide enough to take care of the servicing and engineering requirements of today and tomorrow. It is designed for use with television equipment, radio receivers, transmitters, aircraft radio, sound, facsimile and for other similar types of engineering work.

With it you can measure with speed and accuracy, d-c voltage in high-resistance phototube and photo-cell circuits, television circuits, bias cells and operating voltages across tuned circuits with the signal present. In every case it is the actual operating voltage that is measured, because the VoltOhmyst produces no circuit loading. Its input resistance of 160,000,000 ohms on all ranges between 500 volts and 5,000 volts makes this a universal instrument, truly minimizing obsolescence.

The Rider VoltOhmyst measures 0.05 to 5,000 volts, d. c.—0.1 ohm to 1,000,000,000 ohms with greater convenience than any other existing instrument. The VoltOhmyst has one scale—one zero adjustment. Merely put the proper probe on the point to be measured and the scale shows the voltage or resistance without any adjustments.

The Rider VoltOhmyst is accurate—3% on the Ohmmeter, 2% on the Voltmeter. The input resistance of the Voltmeter is 16,000,000 ohms up to 500 volts and 160,000,000 ohms from 500 to 5,000 volts.

SPECIFICATIONS

VOLTMETER

- RANGES... Nine ranges, 0-5, 10, 25, 100, 250, 500, 1,000, 2,500 and 5,000 volts.
- INPUT RESISTANCE... 16,000,000 ohms on 5, 10, 25, 100, 250 and 500 volt ranges. 160,000,000 ohms on 1,000, 2,500 and 5,000 volt ranges.
- ACCURACY... 2% of full scale

OHMMETER

- RANGES... Seven decade ranges measuring from 0.1 ohm to 1,000,000,000 ohms; 10 ohms center scale on lowest range, 10 megohms center scale on highest range; logarithmic spread over 80% of scale.
- ACCURACY... 3% at center scale

OTHER FEATURES

- METER... Rugged, high torque movement; heavy Alnico magnet providing high flux density; silver-etched dial; 4" scale.
- TERMINALS... Heavy brass, nickel-plated; accommodate banana plugs, phone tips and wire leads.
- TEST LEADS... Two leads, 48" long; special "signal circuit" voltmeter cable equipped with isolating resistor built into bakelite probe sleeve; ground lead with alligator clip.
- CABINET... Welded steel case, sloping front; crystalline gray finish.
- DIMENSIONS... Base—7½" wide x 8¼" deep; height—11"
- SHIPPING WEIGHT... 17 lbs.
- TUBES... 2 RCA-6K6G and 1 RCA-6X5G, total 3
- POWER SUPPLY... 25-60 cycles, 105-130 volts; power consumption 12 watts.

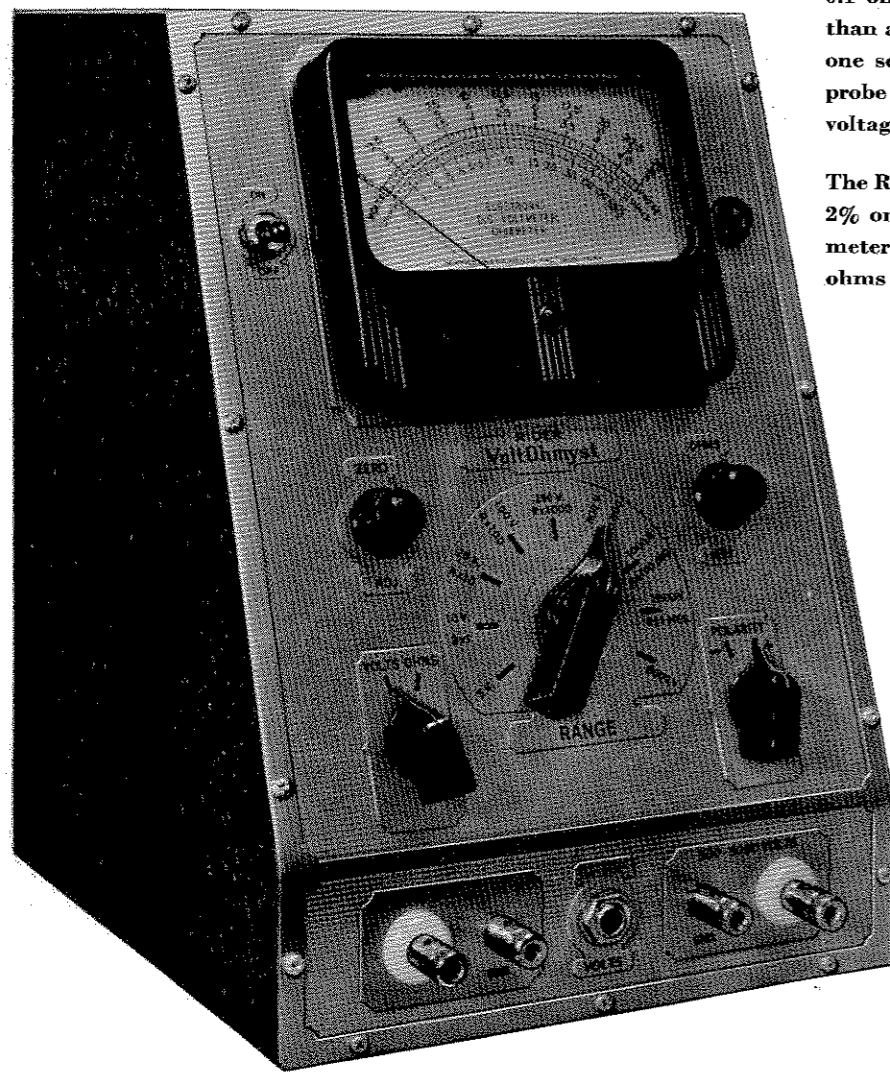

No. 163

JUNIOR VoltOhmyst No. 165

New Push-Pull Electronic Voltmeter-Ohmmeter

The Small, Compact Version of the Rider VoltOhmyst

Complete with Pilot Lamp, 3 tubes, 3 test leads, including a Signal-Tracer type Probe.

Net Price

\$34⁹⁵

Stock No. 165

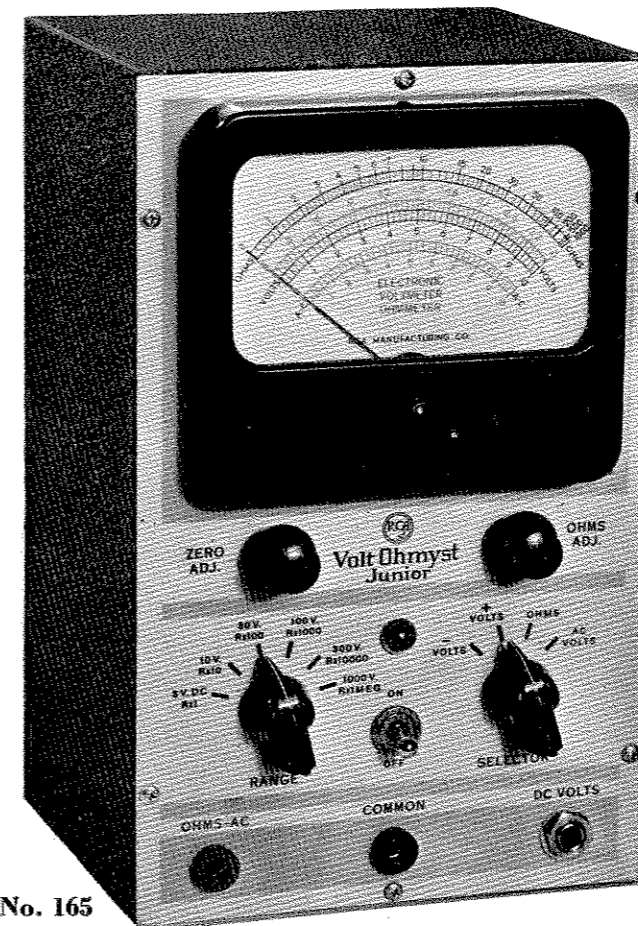

No. 165

A LOW-COST INVESTMENT THAT WILL PAY DIVIDENDS FOR YEARS!

SPECIFICATIONS

The new RCA Junior VoltOhmyst is the ideal push-pull electronic voltmeter-ohmmeter for service shop and similar applications. It is light in weight and easy to handle. Features of the instrument are its extremely high input resistance and stable operation. Its rugged meter withstands great mechanical shock and is provided with complete overload protection for d-c voltage and resistance measurements. Moreover, it is capable of providing accurate readings despite fluctuations in line voltages. The Junior VoltOhmyst measures resistances from 0.1 ohm to 1,000,000,000 ohms and both d-c and a-c voltages up to 1000 volts.

- PUSH-PULL ELECTRONIC CIRCUIT... Accurately balanced; features two separate tubes. No grid current. Stable operation. Controlled inverse feedback. Accuracy unaffected by differences in tube characteristics.
- D-C ELECTRONIC VOLTMETER... 6 ranges—0 to 3, 10, 30, 100, 300, and 1000 volts. Constant input resistance of 11,000,000 ohms for all ranges.
- A-C VOLTMETER... 5 ranges—0 to 10, 30, 100, 300, and 1000 volts. Isolated a-c circuit uses copper oxide rectifier. 1000 ohms/volt sensitivity.
- ELECTRONIC OHMMETER... 6 ranges measuring from 0.1 ohm to 1000 megohms. No zero reset required when changing scales. No leads to short.
- METER ACCURACY... ± 2% at full scale. Matched pair multiplier resistors accurate to ± 1%. Rugged meter movement; withstands mechanical shocks.
- TUBE COMPLEMENT... 2 RCA-6K6-GT's in p-p electronic circuit, 1 RCA-6X5 GT rectifier.
- CABINET... Sturdy welded steel case. Crystalline gray finish. Overall dimensions approximately 9¾" high x 5½" wide x 5⅞" deep. Supplied with test leads. Equipped with black leather handle.
- SHIPPING WEIGHT... Approximately 14 lbs.
- POWER SUPPLY... 105/125 volts, 50/60 cycles
- POWER CONSUMPTION... 12 watts

TUBE TESTER No. 156-E

The world's greatest radio engineering organization plus the world's largest manufacturer of radio tubes have combined to bring you a tube tester that is actually a long term investment. The RCA Radio Tube Tester literally has everything—provisions for heaters up to 120 volts, two spare sockets, additional space on roller chart for 100 new tube types—everything has been provided to make it as nearly obsolescence proof as possible. Not only does it test practically every radio tube, but a socket has been included for checking miniature lamps (Xmas tree types, flashlight bulbs, etc.). Built-in sockets provide for Miniature tubes, Bantam Base types and "Loktal" types. With all of these new features plus the basic easy-testing features—the popular price of \$37.95 has been retained. See what a truly outstanding value it is.

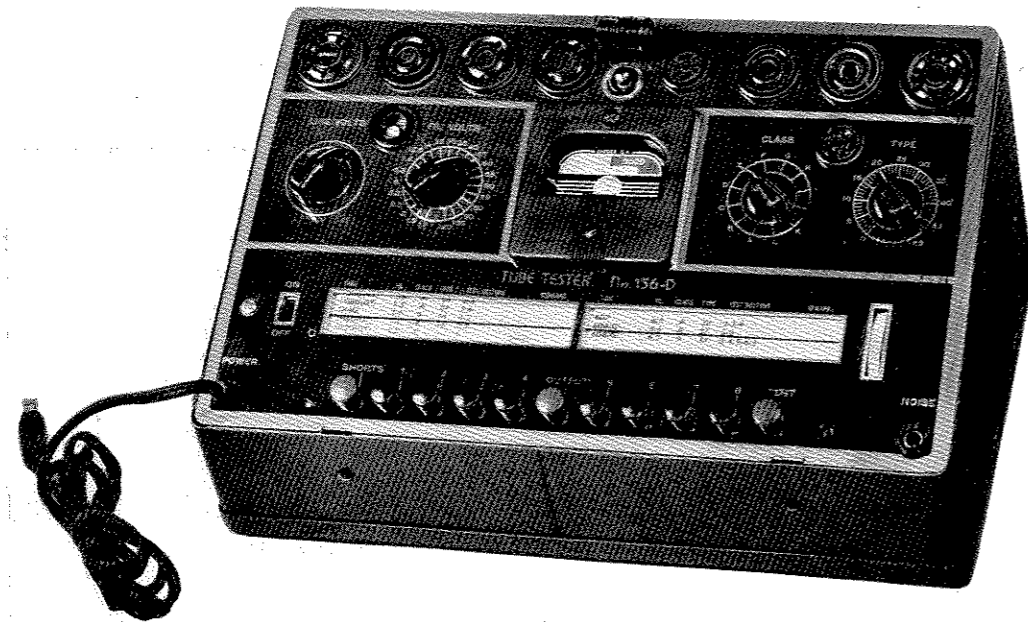

**COUNTER TYPE
TUBE TESTER
STOCK NO. 156-E**

Net Price
\$37⁹⁵

SPECIFICATIONS

- Operates with one finger. Buttons released or retained automatically.
- Shows line voltage up to instant of actual test. Not necessary to set line voltage before inserting tube in socket.
- Makes all tests according to RMA standards.
- Tests Magic Eye Tubes for brilliance and opening and closing of eye.
- Tests four-prong and octal-base ballast tubes for noisy welds and opens.
- Tests voltage drop on all types of Gas Tubes, such as the OA4-G, OZ4-G and 874.
- Tests most types of tubes including Miniatures, Magic Eyes, ballasts, "Loktal" types and "Bantam Base" types.
- Spare switch section and sockets minimize obsolescence.
- Easily read figures on roll chart. Large type with guide lines indicate proper buttons to be pressed.
- Line voltage adjustment for 100-125 volt line.
- Pilot light indicates power "on" or "off."
- DIMENSIONS.....13½" W. x 5¾" D. x 8" H.
- SHIPPING WEIGHT (NET).....15 lbs.
- POWER.....105-125 volts; 50-60 cycles; 25 watts
- CABINET.....Blue-gray wrinkle finish—lithographed panel

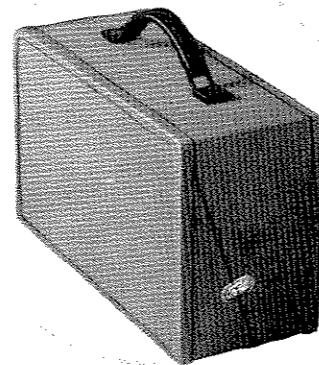

**PORTABLE TYPE TUBE TESTER
No. 156-D**

The portable tube tester, No. 156-D is the same as the type No. 156-E except that it has a completely enclosed-type case with removable lid and snap type handle. The weight is 17 lbs.

Net Price
No. 156-D
Tube Tester **\$39⁹⁵**

DE LUXE TUBE TESTER AND PRE-HEATER

This new unit is your answer to large quantity tube-testing problems. It is equipped with a pre-heating and amplifying unit which enables the test of large quantities of tubes quickly and accurately. With this De Luxe Tube Tester there is no time wasted waiting for tubes to heat up so they may be tested. This instrument pre-heats tubes . . . makes them ready for instant testing. This new Tube Tester and Pre-Heating unit gives you both a visual and an audible check on tubes. The neon tube in the tester supplies the visual check . . . the amplifying unit in the pre-heater gives you an accurate and more sensitive audible check. Moreover, the RCA De Luxe Tube Tester and Pre-Heater instantly tests noisy tubes for such serious conditions as intermittent shorts, open elements, or partial shorts—for which testing facilities have previously been limited. The illustration shows the Tube Tester installed. This is a specially selected tester No. 156S, which has been carefully checked to assure all operating tests are as accurate as can be attained. All other standard features of the No. 156E Tube Tester are included. This equipment was designed to aid YOU to speedily and efficiently test large quantities of tubes. Its use will save you TIME . . . TROUBLE . . . and MONEY.



Stock No.
168 and 156S

SPECIFICATIONS

- Pre-heating of tubes permits testing on a production basis.
- Six octal sockets—four each of other type sockets. TWENTY-TWO PRE-HEATING SOCKETS IN ALL!
- Selector switch—immediately applies the desired voltage to all pre-heating sockets.
- Provides additional audible test for "noisy" tubes.
- Constructed of sturdy metal with a beautiful gray wrinkle finish. Size H 9¼", W 19", D 19½". Weight: 40 lbs., including the 156S tester.

Net Price
Stock No. 168
and 156S **\$122⁵⁰**

INCLUDES THE RCA-156S TUBE TESTER

ACCESSORIES FOR RCA TUBE TESTERS

RCA TUBE TESTER MODERNIZATION KIT

Brings your RCA Tube Tester Models 156, 156-A, 156-B or 156-C (156-B and 156-C with serial numbers under 1000) up to date. Makes it the electrical equivalent of the recently announced Models 156-D and 156-E. The kit contains a transformer having a filament voltage range up to 120 volts, a switch, escutcheon, latest edition of the roll chart, an adaptor for testing "Bantam Base" type tubes, and all necessary hardware.

Stock No. 9901.....Net \$6.25
Stock No. 9863—"Loktal" type Socket Kit..... .50
(Illustrated and designed for Loktal Tubes unless adaptor is used.)

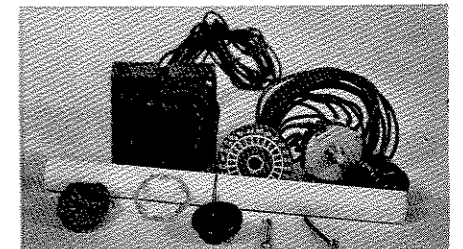

SOCKET ADAPTORS

Handy adaptors to test the Miniature, "Loktal" and "Bantam Base" type tubes on RCA Tube Tester Models 156, 156-A, 156-B and 156-C (156-B and 156-C with serial numbers under 1000). Makes testing of these tubes easy.

Stock No. 9905 RCA Miniature type..... } Net Price
Stock No. 9858 "Loktal" type..... } **\$.50**
Stock No. 9906 "Bantam Base" type..... }

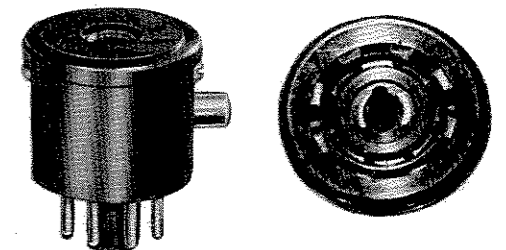

3" CATHODE-RAY OSCILLOGRAPH

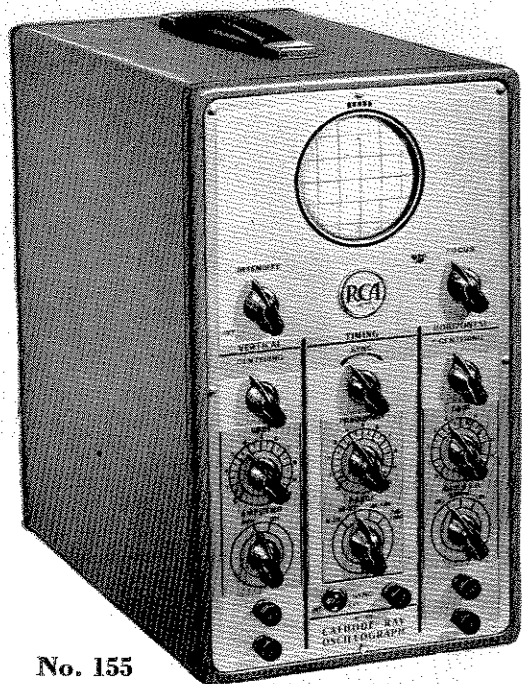

The RCA 3-inch Cathode-Ray Oscilloscope is ideal for the vast majority of service applications. The image it produces is quite large. Its controls are simple and easy to operate. All controls, including the spot-centering controls, are located on the front panel. Greater portability is achieved through reduced size and weight. Attractive styling, more flexible electrical design and better performance make this instrument unusually attractive. This oscilloscope employs the cathode ray tube RCA-3AP1/906-P1, an improved type having Aquadag coating and a medium-persistence screen.

SPECIFICATIONS

- SENSITIVITY... Without amplifier — 20 volts (RMS) per inch deflection. With Amplifier—0.5 volt (RMS) per inch deflection.
- AMPLIFIER RESPONSE... Flat, 20-90,000 cycles.
- AMPLIFIER GAIN..... 40
- TIMING AXIS..... 15-22,000 cycles
- TUBE COMPLEMENT..... 1 RCA-3AP1/906-P1, 2 RCA-6C6's, 2 RCA-80's, 1 RCA-884.
- POWER SUPPLY 105/125 volts, 50-60 cycles; power consumption, 50 watts.
- CABINET... Blue-gray baked wrinkle lacquer finish with streamlined handle. Copper plating on chassis and inside of panel and cabinet. 15" high, 8" wide, 14" deep.
- SHIPPING WEIGHT 32 lbs.

Net Price
\$63⁹⁵
Stock No. 155

No. 155

5" GENERAL-PURPOSE OSCILLOGRAPH

This fine instrument embodies all of RCA's skill and experience in oscilloscope manufacture. Not only will it perform all the functions of other RCA Oscilloscopes (except the Television model) but it may also be used for engine-pressure measurements and similar applications. The amplifiers have unusually wide frequency range and sensitivity. The 5" screen gives an easily read image. All controls are conveniently located on the front panel. Compact construction provides easy portability. Beautifully styled in true RCA manner.

SPECIFICATIONS

- DEFLECTION SENS. AT VERT. AMP. INPUT (gain max.)... 0.013 Volt RMS per inch
- DEFLECTION SENSITIVITY HORIZ. AMP..... 0.56 Volt RMS per inch
- INPUT AT VERTICAL AMP. INPUT..... 500,000 ohms
- INPUT HORIZONTAL AMP..... 500,000 ohms, 20 mmf.
- FREQ. CHARACTERISTIC VERT. AMP. (gain max.)... 3 cycles—50 kc. sine wave, permitting square wave response 7-2,000 cycles.
- FREQ. CHARACTERISTIC HORIZ. AMP..... 5 cycles—100 kc. sine wave
- MAX. SIGNAL INPUT TO VERT. AMP..... 500 volts, RMS
- MAX. SIGNAL INPUT TO HORIZ. AMP..... 500 volts, RMS
- HORIZONTAL SWEEP VOLTAGE..... 4 cycles to 22,000 cycles
- POWER SUPPLY... 105-125 volts; 50-60 cycles; 55 watts
- CABINET..... Blue-gray baked wrinkle finish
- SIZE..... 14 1/4" High x 8" Wide x 19 1/4" Deep
- SHIPPING WEIGHT 40 lbs.

Net Price
\$130⁰⁰
Stock No. 160-B

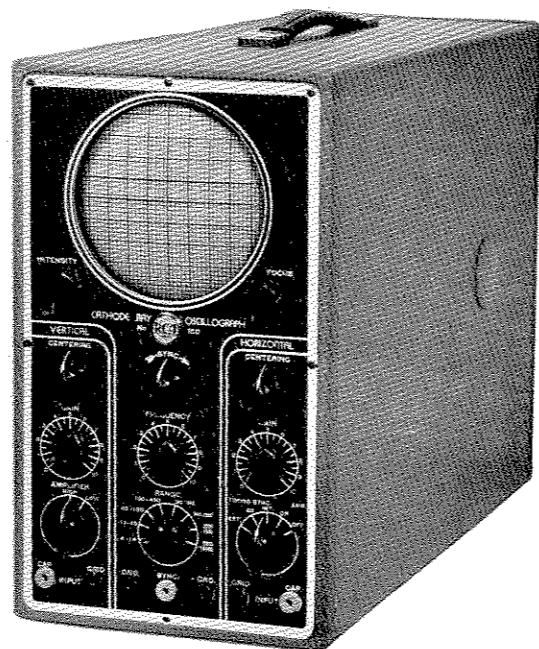

Stock No. 160-B

TUBE COMPLEMENT
1 RCA-879; 1 RCA-80; 1 RCA-5BP1/1802-P1; 1 RCA 884;
3 RCA-6C6's; 1 VR-105; 1 VR-150.

2" CATHODE-RAY OSCILLOGRAPH



No. 151-2

This fine portable instrument has every important feature needed in a modern cathode-ray oscilloscope. An important feature of the unit is its tilt-mounted screen which is calibrated and easily read. All controls, including the centering controls, are located on the front panel for handy operation. High-gain amplifiers are used for both vertical and horizontal deflection to insure high sensitivity.

SPECIFICATIONS

- SENSITIVITY..... 0.5 volt RMS for full-scale deflection (with amplifier)
- AMPLIFIER RESPONSE..... Flat between 20 and 15,000 cycles
- AMPLIFIER GAIN..... 50
- TIMING AXIS..... 30 to 10,000 cycles (horizontal sweep)
- TUBE COMPLEMENT... 1 RCA-902 (2-inch), 1 RCA-885, 2 RCA-6C6's, 1 RCA-80
- POWER SUPPLY... 110/120 volts, 50/60 cycles; power consumption, 30 watts.
- CABINET... Sturdy case. Gray-wrinkle lacquer with nickel trim. Reversed etched nickel-silver panel. Large, soft-rubber feet. Special Snap Handle. 13 3/4" long x 9 1/4" high x 7 3/4" deep.
- SHIPPING WEIGHT... 25 lbs.

Net Price
\$49⁹⁵
Stock No. 151-2

5" TELEVISION OSCILLOGRAPH

This precision instrument has been designed for service work in accordance with present television receiver development plus anticipation of future television progress—thereby minimizing obsolescence. A special input cable having high input resistance and low capacity is provided. The 5-inch screen gives a large image of unusual clarity preferable for the finest work. All controls—including those for spot centering—are located on the front panel and are of the easily adjusted bar type. A special step-attenuator together with a fine gain control to cover the control between the attenuator steps is provided to prevent changes in frequency characteristics at various input levels. Provision is made for synchronization on positive or negative peaks. This is an important feature, for in certain television tests it is desirable to choose which is to be used. In television service this capable Oscilloscope is ideal for viewing synchronizing and blanking impulses, horizontal and vertical sawtooth waves, and grid and plate voltages on horizontal and vertical oscillators. It is easily portable and is styled in traditional RCA manner, with a finish that is both attractive and durable. 4 ft. low capacity (8 mmf.) input cable included.

SPECIFICATIONS

- DEFLECTION SENS. AT VERT. AMP. INPUT (max. gain)... 0.040 V. RMS/inch (less cable).
- DEFLECTION SENS. AT VERT. AMP. WITH CABLE... 0.3 V. RMS/inch.
- DEFLECTION SENS. HORIZ. AMP... 0.56 V. RMS/inch.
- FREQ. CHARACTERISTIC VERT. AMP. (max. gain)... 5 cycles to 500 kc. Sine wave permitting square wave response 60-13,000 cycles.
- FREQ. CHARACTERISTIC HORIZ. AMP... 5 cycles to 100 kc.
- POWER... 110 - 120 volts; 50 - 60 cycles; 55 watts.
- HORIZONTAL SWEEP FREQUENCY RANGE... 4 cycles to 22,000 cycles.
- CABINET... Blue-gray baked wrinkle lacquer finish with streamlined snap-in handle.
- SIZE..... 14 1/4" x 8" x 19 1/4"
- SHIPPING WEIGHT..... 30 lbs.

Net Price
\$147⁵⁰
Stock No. 158-D

TUBE COMPLEMENT
1 RCA-5BP1/1802-P1; 1 RCA-1852; 1 RCA-879;
1 RCA-6C6; 1 RCA-6SJ7; 1 RCA-80; 1 RCA-884.



No. 158-D

THE RCA SIGNALYST

FUNDAMENTAL FREQUENCY RANGE

100 Kilocycles to 120 Megacycles

Net Price **\$107⁵⁰** Stock No. 161

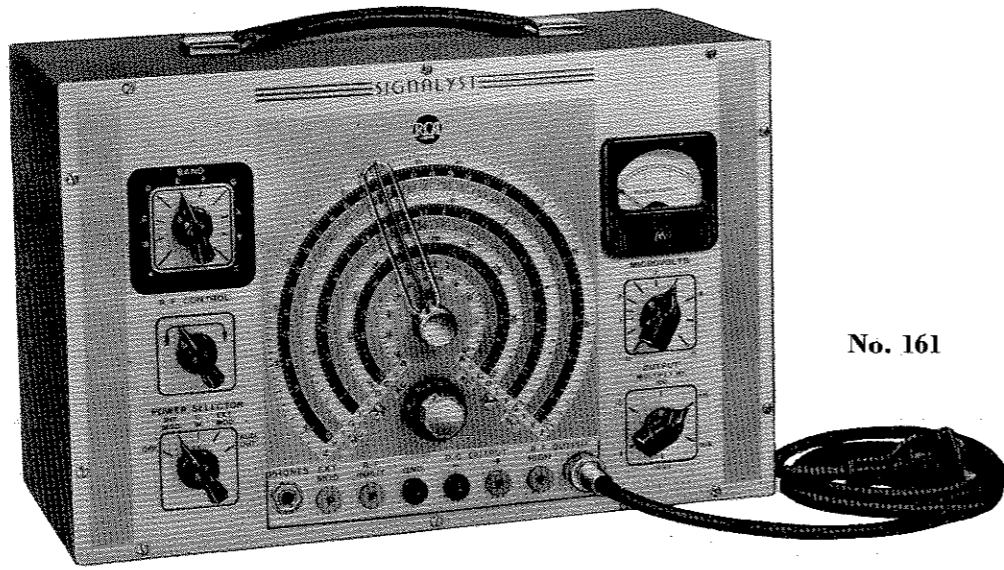

No. 161

MEET PRESENT SERVICE REQUIREMENTS AND THE FUTURE DEMANDS OF TELEVISION, FACSIMILE, ETC.

This modern precision signal generator of critical laboratory design provides accurate FUNDAMENTAL frequencies from 100 kc. to 120 Mc in 10 bands. Circuit consists of an oscillator stage, a buffer-modulator stage, and an output metering circuit. Handles ALL radio receiver alignment jobs . . . broadcast, short-wave, or special-purpose. Eliminates all need for relying on unstable harmonics. Use of meter in conjunction with ladder-type attenuator, provides direct reading of output in microvolts.

SPECIFICATIONS

- Dial calibration accuracy better than 1%. Circuits aligned at each end of each band to within 0.05% accuracy.
- 3-color dial easy to read. Scale approx. 90° long. Tuning ratio 60:1 and 12:1.
- Coaxial cable output minimizes stray leakage.
- Built-in Heterodyne Detector permits crystal calibration for extreme accuracy of dial settings.
- Internal 400-cycle modulation; 400-cycle output.
- Permits amplitude modulation up to 5 Mc.
- Regulated plate- and screen-voltage supplies.
- Tube Complement: RCA-6J5 as oscillator, RCA-6SA7 as buffer-modulator, RCA-6F7 as a combination modulator and heterodyne detector, RCA-6H6 as voltmeter rectifier, RCA-VR-150 voltage regulator, RCA-5W4 power rectifier.
- Power supply 105-125 volts, 50/60 cycles; power consumption 35 watts.
- Beautiful brush chrome metal case with convenient leather carrying handle. Panel is in brush and bright chrome. Size 9 3/4" High x 8" Deep x 14" Long.
- Carrying weight 21 lbs.—Shipping weight 24 lbs.
- Power supply: 105/125 volts, 50/60 cycles; 35 watts.

ELECTRONIC SWEEP TEST OSCILLATOR

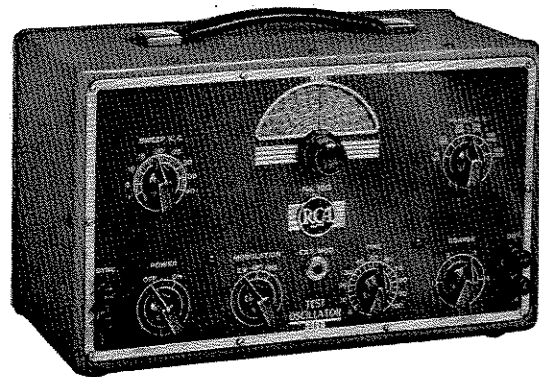

This fine oscillator not only offers every important feature for servicing all radio receivers but also has the additional highly desirable quality of having its own internal electronically operated frequency modulator for visual oscillographic alignment. This permits visual alignment of a receiver with any oscillograph, or, it may be used alone with an output indicator such as the VoltOhmyst No. 163 or Junior VoltOhmyst No. 165.

SPECIFICATIONS

- FREQUENCY RANGE . . . 90 to 32,000 kc. in 6 fundamental frequency ranges.
- MODULATION AMPLITUDE . . . 400 cycles at 30% modulation. Frequency adjustable from 1 to 40 kc. at a rate of 120 cycles per second.
- OUTPUT VOLTAGE . . . 0.25 V., max., on all frequencies.
- OUTPUT CONTROL . . . 3-step attenuator, plus continuously variable control.
- TUBE COMPLEMENT . . . RCA - 6A7 variable frequency oscillator and mixer. RCA-6F7 fixed-frequency oscillator and 400-cycle oscillator.
- DIAL . . . 4" in diameter. Scale length 45°. Direct reading. Indirect illumination. No parallax. Tuning ratio 5 to 1 and direct drive. Calibration accuracy, 1%.
- POWER SUPPLY . . . Integral part of the oscillator. Operates from a 110 / 120 - volt, 50 / 60 - cycle line. Power consumption is 30 watts.
- CABINET . . . Sturdy, gray-wrinkle lacquer with nickel trim. Reversed etched, nickel-silver panel. Special Snap Handle. 13 3/4" long x 9 1/4" high x 7 1/2" deep.
- SHIPPING WEIGHT . . . 22 lbs.

Net Price **\$64⁵⁰**

Stock No. 150
110/120-volts, 50/60-cycles

Net Price **\$72⁵⁰**

Stock No. 150-A
110/120-volts, 25-cycles

A-C TEST OSCILLATOR

OPERATES ON ALL RANGES AT FUNDAMENTAL FREQUENCIES

The serviceman who wants a comparatively inexpensive, electron-coupled signal source that is stable and well-calibrated will find his requirements *fully* met in the new RCA Model 167 A-C Test Oscillator. This dependable instrument, with its wide frequency range and its unusually high output, is designed to meet every requirement in the servicing of most complex receivers. The giant dial scale (covers 10 inches alone on h-f range) is extremely easy to read and has a calibration accuracy of 2%. No. 167 Oscillator includes a 36-inch, low-capacity output cable to permit connection to any desired point in the receiver under test. The RCA metal tubes used in this oscillator provide high circuit stability.

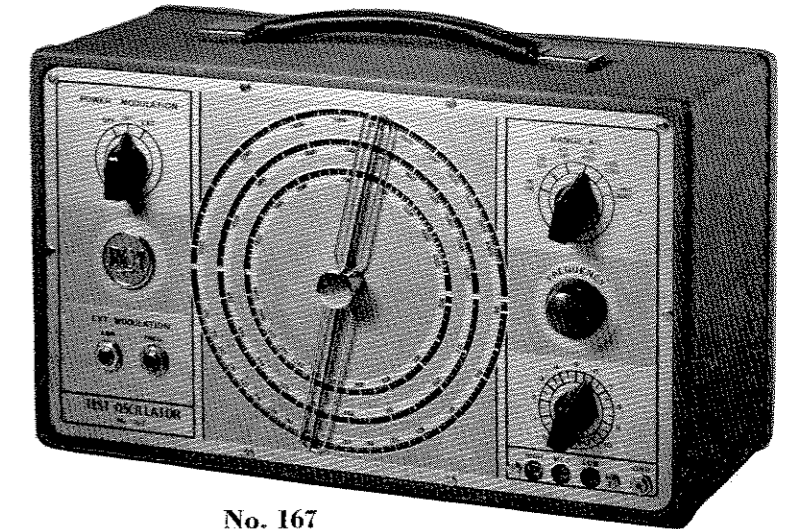

No. 167

SPECIFICATIONS

- R-F RANGE . . . 100 to 30,000 kc. in 6 bands—all fundamental frequencies. (Harmonics of last band may be used for U. H. F.)
- AUDIO MODULATION FREQUENCY . . . 400 cycles. 8 volts available for audio circuit testing.

Net Price **\$34⁵⁰**

Stock No. 167

- MAX. R-F OUTPUT VOLTAGE . . . Low range, 0.01v. Medium range, 0.25v. High range, 1.0v.
- OUTPUT IMPEDANCE . . . 10, 750, and 4,000 ohms.
- TUBE COMPLEMENT . . . RCA-5W4 rectifier, RCA-6C5 audio oscillator, RCA-6J7 r-f oscillator.
- POWER SUPPLY . . . 110/120 volts, 50/60 cycles; power consumption, 30 watts. Fuse protection.
- CABINET . . . Blue-gray wrinkle lacquer. Brush and bright chrome panel. Special Snap Handle. Large, soft-rubber feet. 13 3/4" long x 9 1/4" high x 6 1/2" wide. Shipping weight, 16 lbs.

BEAT-FREQUENCY AUDIO OSCILLATOR

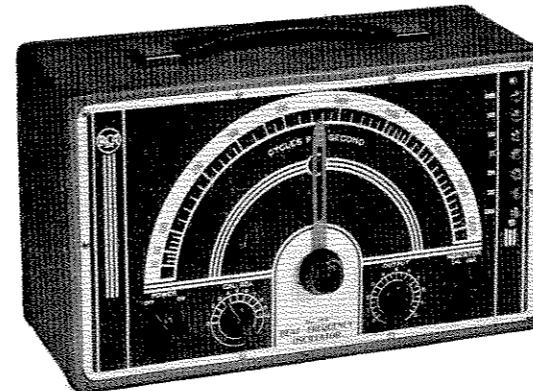

The RCA Beat-Frequency Audio Oscillator is an instrument that should be in the shop of every service engineer. It gives a variable frequency source of alternating current voltage from 30 to 15,000 cycles—more than the range of the finest radio receivers. It is excellent for testing loudspeakers, PA systems, locating cabinet rattles, and running fidelity curves on radio receivers. It has many other important service applications. Provides choice of 3 output impedances through medium of tapped output transformer. Has large 8 3/4 inch logarithmic type dial spread over approximately 160 degrees for accurate setting. Attractive gray wrinkle finish with special snap handle.

SPECIFICATIONS

- OUTPUT FREQUENCY . . . 30 to 15,000 cycles ± 1 db. from 30 to 10,000 cycles. Down 2 db. at 15,000 cycles.
- OUTPUT VOLTAGE RANGE . . . 5.2 volts at 250-ohm load to 37.5 volts at no load
- OUTPUT IMPEDANCE . . . 250, 500, and 5,000 ohms
- POWER OUTPUT . . . 125 milliwatts
- HUM LEVEL . . . -60 db. below maximum output
- DISTORTION . . . Less than 5% RMS over entire range
- TUBE COMPLEMENT . . . RCA-6J7 fixed r-f oscillator, RCA-6J7 audio oscillator, RCA-6C5 detector, RCA-6J5 r-f amplifier, RCA-5W4 rectifier.
- POWER SUPPLY . . . 110/120 volts, 50/60 cycles; power consumption 35 watts. Fuse protection.
- CABINET . . . Attractive gray wrinkle finish with special snap handle. 9 1/2" high x 13 1/4" long x 6 1/2" wide.
- SHIPPING WEIGHT . . . 19 lbs.

Net Price **\$49⁹⁵**

Stock No. 154

RCA TEST OSCILLATORS

TELEVISION ALIGNMENT OSCILLATOR



This newly developed instrument is specifically designed for visual alignment of the r-f and i-f circuits in television receivers. When used with a cathode ray oscillograph (such as the RCA Stock No. 158) the selectivity curve of the circuits under test is produced on the television screen. Operation of the television alignment oscillator is surprisingly simple. The four controls include a power selector switch for selecting i-f or r-f operation; two range switches for selecting the desired i-f and r-f channels; and the phase control and switch for adjusting the oscillograph horizontal deflection to provide single image operation. The output frequency sweeps through the r-f and i-f bands at a rate of 60 c.p.s. providing a steady, non-flickering pattern on the oscillograph screen. R-f and i-f coaxial transmission line with proper terminating loads are included.

SPECIFICATIONS

- OUTPUT SIGNALS... Output frequency sweeps through the following bands—RF-43-51 mcs., 49-57 mcs., 65-73 mcs., 77-85 mcs. and 83-91 mcs. IF-7.5 to 15 mcs. (Picture Channel), 7.75 to 8.75 mcs. (Sound Channel).
- OUTPUT VOLTAGES... 2 values for each signal approximately 0.3 volts and 0.03 volts.
- CABINET... Baked lacquer, fine blue-gray wrinkle. Special Snap Handle. 9 1/4" High x 13 3/4" Wide x 6 1/2" Deep.
- POWER SUPPLY... Self-contained for use on 110-120 volts, 60 cycles. Power consumption, 50 watts.
- SHIPPING WEIGHT... 21 lbs.

Net Price
\$130⁰⁰
Stock No. 159

TUBE COMPLEMENT
2 RCA-6J5; 2 RCA-1851; 1 RCA-6SK7; 1 RCA-5W4; 1 RCA-VR-150/30.

CRYSTAL (PIEZO-ELECTRIC) CALIBRATOR No. 9572

RCA Crystal Calibrator No. 9572 is a crystal-controlled oscillator similar in design to Crystal Calibrator No. 157 but having modes of oscillation at 100 kc. and 1,000 kc. A "Hi-lo" switch is provided for selection of the mode desired. No. 9572 produces a wide range of strong, reliable harmonics from 100 kc. to 20,000 kc. in 100-kc. steps and from 1,000 kc. to 50,000 kc. in 1,000-kc. steps. Guaranteed accuracy is within 0.05%. No. 9572 is useful for general-purpose applications. Like the No. 157, it contains an RCA-955 Acorn triode tube. Calibrating temperature furnished on each individual unit.

Net Price
\$29⁹⁵
No. 9572

CRYSTAL (PIEZO-ELECTRIC) CALIBRATOR No. 157

RCA Crystal Calibrator No. 157 is a crystal-controlled oscillator having two modes of oscillation and a wide range of strong, reliable harmonics. Fundamental oscillating frequencies are at 250 kc. and 2,000 kc. A "Hi-lo" switch is provided for the selection of the frequency mode desired. It provides laboratory accuracy for checking oscillators and receiver alignment points throughout the radio spectrum. It is particularly useful for u-h-f work, including the television frequencies. Guaranteed accuracy is within 0.05% of specified frequency. No. 157 uses a tiny Acorn tube, is easy to carry, and can be plugged in any 110-v. a-c supply, ready to use. Calibrating temperature furnished on each individual unit. RF Output jack provided.

SPECIFICATIONS

- FUNDAMENTAL FREQUENCIES... 250 kc. and 2,000 kc.
- CALIBRATION ACCURACY... 2 parts in 1,000,000
- TEMPERATURE COEFFICIENT... 20 cycles/1,000 kc./°C.
- POWER SUPPLY... 110/120 volts, 50/60 cycles—plug in anywhere. Power consumption, 2 watts. Terminals for d-c plate supply.
- TUBE COMPLEMENT... 1 RCA-955 Acorn Type.
- SIZE... Only 5 1/2" x 2 7/8" x 2 5/8"
- SHIPPING WEIGHT... 2 lbs.

Net Price
\$46⁵⁰



No. 157 and No. 9572

UNIVERSAL A-C BRIDGE

MEASURES Inductance... 100 microhenries to 10 henries
Capacity... 10 micro-microfarads to 10 microfarads
Resistance... 1 ohm to 1 megohm

Here is an instrument that simplifies and speeds the analysis of many service or laboratory problems. It quickly checks inductance, capacity and resistance over extremely wide ranges. The only additional equipment needed is a headphone for use as a null indicator. This Universal A-C Bridge assures you of the finest engineering and quality. It's an instrument that will enable you to put accuracy into your work.

SPECIFICATIONS

- CIRCUIT... Variable—Ratio—Arm A. C. Wheatstone Type Bridge.
- TUBE COMPLEMENT... 1 RCA-25Z5, 1 RCA-76, 1 RCA-6F7.
- SIZE... Case 6 1/2" x 9 3/4" x 4 1/2"
- SHIPPING WEIGHT... 5 1/2 lbs.
- RANGES... Resistance, 1 ohm to 1 megohm. Inductance, 100 microhenries to 10 henries. Capacitance, 10 mmf. to 10 mf. Accuracy, 5% overall at full scale.
- POWER SUPPLY... 110-120 volts, 25-60 cycles a.c. Power consumption, 40 watts.
- FREQUENCY OF AUDIO OSCILLATOR... 1,000 cycles ± 10%.

Net Price
\$49⁶⁵

Stock No. 9600
Complete with all tubes and standards.



No. 9600

FREQUENCY MODULATOR

The RCA Frequency Modulator is a motor-driven unit designed to modulate the r-f frequency of your test oscillator (such as No. 167 or 161) over a range sufficient for visual alignment with your oscillograph. It sweeps the r-f voltage over the resonant frequency of the circuit under test and generates an a-c synchronizing voltage simultaneously. Permits the use of the reverse sweep method of alignment, the method used by all leading radio manufacturers. It is for use *only* with oscillators not having internal frequency modulations.

SPECIFICATIONS

- TUNING CAPACITOR... Two sections—each 35 mmf. capacity. Switch for connecting either or both in circuit.
- CONNECTING CABLE... 14-inch low-capacity connecting cable with plugs at each end.
- GENERATOR FREQUENCY... Two cycles per revolution for positive synchronizing with double-sweep alignment.
- GENERATOR VOLTAGE... 1.5 volts minimum.
- MOTOR... Repulsion induction type—1550 r.p.m.
- PANEL CONTROLS... "Hi-Lo" capacity switch, "On-Off" switch, output binding posts and single-circuit jack.
- CABINET... Gray wrinkle lacquer finish to match other RCA Test Equipment. Case (excluding handle) 6 1/2" x 9 3/4" x 4 1/2". Shipping Weight, 5 1/4 lbs.
- CURRENT CONSUMPTION... 25 watts.
- POWER SUPPLY... 110 volts, 60 cycles a.c.

Net Price
\$27⁵⁰

Stock No. 9558

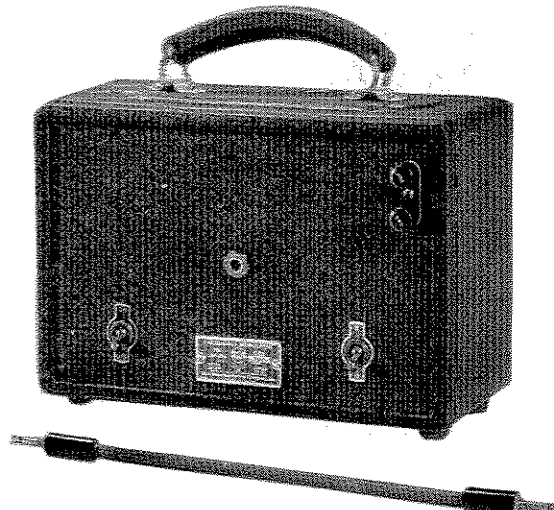

No. 9558

AERODYNAMIC MICROPHONES

Ideal for every public address, amateur or experimental use—this new microphone is of the pressure-operated dynamic type. It is insensitive to mechanical vibration. Requires no excitation or power supply. The low impedance type may be located up to 1,000 feet from the input amplifier. Both types are fitted with a 30-foot shielded cable. Both are impervious to changes in temperature, humidity and barometric pressure and have a minimum wind response. Thoroughly shielded and not affected by r-f or a-c fields. Includes fitting for adapting 1/8" pipe fitting to 5/8"—27 threads used on standard microphone stands.

SPECIFICATIONS

- TYPE... Pressure operated
- FREQUENCY RANGE... 100 to 6,000 cycles.
- IMPEDANCE... 250 ohms or 40,000 ohms.
- AVERAGE OPERATING LEVEL... -68 db. (10 bar signal across open circuit).
- DIMENSIONS... 2 5/8" wide, 3" high, 3 3/8" deep.
- NET WEIGHT... 1 1/4 lbs.
- FINISH... Polished chromium

List Price
\$19⁹⁵

Low impedance type—250 ohms
Stock No. MI-6226-D
Less Stand

Stock No. MI-6223-B—High impedance type—40,000 ohms, includes 30 feet shielded cable—**\$21.95**
List Price—less stand
Stock No. MI-6232-A—Table stand shown at left. Finished in chromium and black with felt covered base. List Price... **\$2.65**

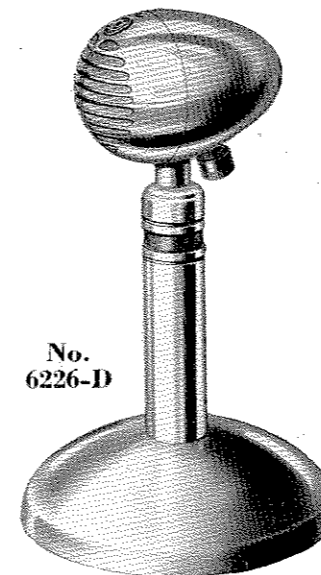

No. 6226-D

DI-POLE REFLECTOR TELEVISION AND FM ANTENNA

The Di-Pole Antenna and reflector, No. 9886, is your best assurance for satisfactory reception of television pictures and their accompanying sound reception, as well as for the increasingly popular FM broadcasts. The design of this antenna is based on scientific principles. It will give excellent performance on any of the ultra-high-frequency bands between 44 and 90 Mc and can be mounted for reception of either vertically or horizontally polarized waves, depending on the type of antenna system used by the FM or Television broadcast station. When reception of two television stations is desired, or a double Di-Pole arrangement is required, an additional Di-Pole section may be added to the first. No. 9886 antenna may also be used for reception in the short-wave and standard broadcast bands with RCA receivers equipped for such reception on a television antenna. No. 9886 is complete with two threaded antenna rods, two threaded reflector rods, a wooden cross arm, a connector strap, a mast-mounting clamp, and necessary hardware. All parts fully weather-proofed. Stock No. 9886..... List Price **\$8.75**
 Stock No. 9887. Connector Straps for connecting two Stock No. 9886 for double Di-Pole..... List Price **.65**

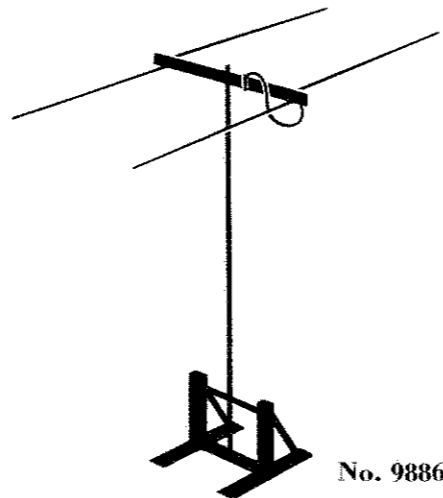

No. 9886

DOUBLE V TELEVISION AND FM ANTENNA

The RCA Victor No. 9870 Antenna is designed for installation where reflection problems are not encountered. (Suitable for most suburban areas.) The Double "V"-Type Antenna is packed completely assembled (needing only supports for either end) for reception on the 44-50 Mc and the 50-56 Mc bands. By changing the length of the wires between the hanger insulator and the center of the junction box, reception of other Television channels may be obtained. A junction box, 90 feet of transmission line, and full installation instructions are included with each antenna. All parts are weather-proofed to give a long trouble-free service.

STOCK NO. 9870 LIST PRICE **\$4.00**

ACCESSORIES FOR THE 9886 ANTENNA

Stock No.	List Price
9873—Galvanized Mounting Bracket—complete.....	\$8.75
12430—Transmission Line—90 feet.....	3.75
9881—Transmission Line—1,000-foot spool.....	19.30
9882—Transmission Line—1,000 feet—special low-loss type.....	125.00
9883—Transmission Line—1,000 feet—white—for indoor use.....	18.00
9884—Transmission Line—1,000 feet—brown—for indoor use.....	18.00
9885—Distribution Transformer (provides for operation of 4 receivers from one antenna).....	5.50

AUTOMOBILE DI-POLE ANTENNA

At an unusually attractive price, the RCA Di-Pole Antenna has been the popular choice for under-car installations. Ignition interference is greatly reduced. In areas where the signal level is low, two RCA Di-Pole Antennas may be used, one under each running-board. Price includes a 50-inch shielded lead-in cable with bayonet connector and all necessary fittings. List Price **\$260**
 Stock No. 9605

List Price **\$260**

Stock No. 9605

OUTPUT INDICATOR

This is a "burn-out proof" instrument that serves as an excellent indicating device for aligning receivers. You see the actual amount of light that the voice current produces. Merely align your trimmer for the greatest brilliancy of the neon lamp. Works with any dynamic loudspeaker. Consists of a tapped step-up transformer, a potentiometer, a glow tube and three binding posts for connecting the output of the receiver to the transformer—all mounted in a die-cast bakelite case.

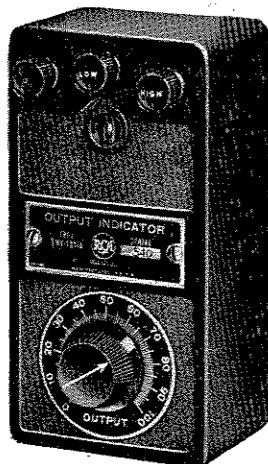

\$400

Stock No. 4317 NET

SPECIFICATIONS

- SIZE..... 5 3/8" x 2 7/8" x 2 5/8". Weight, 12 oz.
- LAMP RATING..... 50-60 volts breakdown
- TRANSFORMER RATIO. 80:1 (Maximum)
- INPUT IMPEDANCES... 0 to H, 4 ohms; 0 to L, 1 1/2 ohms; H to L, 0.6 ohm.

RCA VICTOR MASTER ANTENNA

For those difficult installations where extreme local noise cannot be eliminated by the usual noise-reducing antenna, the RCA Victor Master Antenna will often solve the problem. A new unique noise-balancing circuit, which is *individually adjusted* for each installation, gives a high degree of noise reduction, especially when the noise is from near-by electrical devices. This antenna is *not* dependent on location for its noise-reducing qualities.

The frequency range covered is from 540 to 23,000 kc. including all standard broadcast and foreign short-wave bands. List Price

Stock No. 9852 (Model MA) less Receiver Coupling Transformer.. **\$5.00**
 Stock No. 9846 Receiver Coupling Transformer..... **1.95**

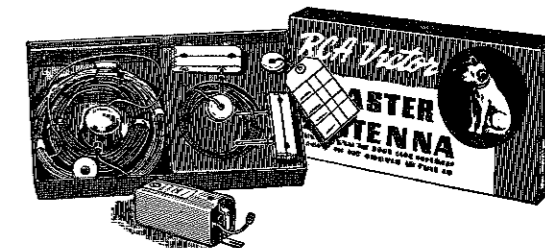

No. 9845

395 ANTENNA SYSTEM

At a figure everyone can afford to pay it is a scientifically designed system, operates perfectly with receivers of all types and manufacture and is unusually easy to install. Requires only two supports, 40 feet apart. All parts, including antenna wires, strain insulators, junction box, etc., are assembled and soldered.

Cash in on this low-priced antenna. Recommend it to your customers who need a quality antenna at a popular price. List Price

CONTENTS OF KIT: 2 Antenna Wire Coils—Each 20 feet long, 2 Strain Insulators, 1 Transmission Line—60 feet, 1 Junction Box, 1 Receiver Coupling Unit, 2 Coupling Unit Links, 2 Nail-On Knob Insulators, 1 Ground Clamp, 1 Instruction Sheet. **\$3.95**
 Stock No. 395

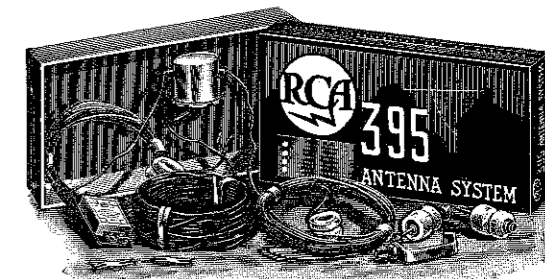

No. 395

Stock No. 12855, Set Coupling Unit for 395 and RK-40 Antennas List..... **\$3.75**

ADDITIONAL TRANSMISSION LINE
 (For types not listed here, see page 14)

Stock No. 9816, 60 feet for No. 395, No. 9845, or No. 9852 Antenna **\$1.50**

SPIDER-WEB ANTENNA

A Transoceanic Communications type antenna for the home. The RCA Spider-Web Antenna System gives excellent signal pick-up over the frequency range from 140 to 23,000 kc. By adding the stock No. 9689 High Frequency Kit, the range is increased to 70,000 kc. with full noise reduction. Complete factory assembling and soldering of all parts makes installation rapid and easy. Proper design requires only a span of 38 feet and a vertical clearance of 12 feet.

This antenna consists of a series of doublet antennas and an improved transmission line which gives the utmost in noise reduction of the signal pick-up over an extremely wide range. It is RCA's finest antenna, especially recommended for amateur and short wave reception. List Price **\$8.95**
 Stock No. 9685

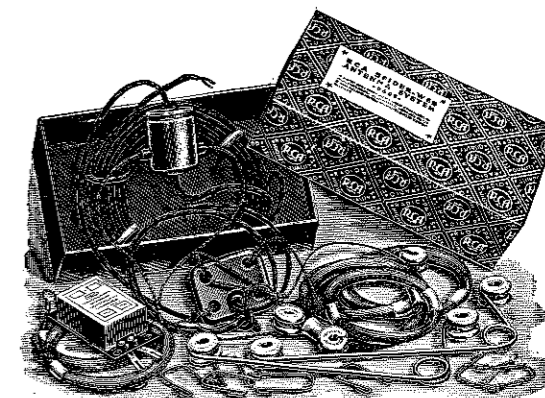

No. 9685

Stock No. 9689 High Frequency Kit..... List **\$1.50**
 Stock No. 12430 90' Transmission Line for 9685, 9812..... List **\$3.75**

IMPROVED MAGIC-WAVE ANTENNA

A new highly efficient noise reducing antenna for every type of radio installation. Provides noise reduction on both standard and foreign broadcast bands (530 to 23,000 kc.), flexibility in installation and high signal pick-up. In no other RCA antenna can you obtain *all* of the following features:

- Built-in lightning arrester in antenna coupler.
- Operates up to 16 outlets from 1 antenna with additional coupling and distribution transformers (only slight reduction in signal strength).
- Easily installed. Completely assembled and soldered.
- Antenna may be from 20 to 120 feet long.
- Transmission line may be any length up to 500 feet.
- 30-foot length of pipe may be used for vertical antenna with underground transmission line.
- Uses magnetite core transformers.
- Can easily be attached to existing antennas.

List Price **\$5.95**

Stock No. 9812

(Includes complete assembly for single outlet installation.)

Stock No. 9849, Antenna Coupling Transformer with Built-in Lightning Arrester (for assembling your own kit)..... **\$2.00**
 Stock No. 9814, Distribution Transformer..... **\$3.00**
 (1 required for each 4 additional receivers)
 Stock No. 9813, Set Coupling Transformer..... **\$2.50**
 (1 required for each additional receiver)

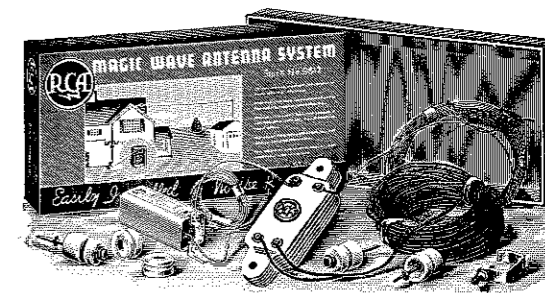

No. 9812

RCA VICTOR RECORD PLAYER MODEL R-93F

An inexpensive instrument that quickly converts any modern a-c radio into an electrical radio-phonograph combination. Plays both ten- and twelve-inch records with all the volume and fidelity of the set to which it is attached. Includes cushion-mounted, constant speed electric motor, latest type feather-touch crystal pick-up in modern bakelite tone arm. Arm easily tilted to the vertical position for insertion of needle.

SPECIFICATIONS

- PICK-UP IMPEDANCE...100,000 ohms at 1,000 cycles.
- CABLE CONNECTION...32-inch cable with male fitting for connection to 1940 RCA Victor radios. Use No. 9824 Switch and Cable Assembly shown on page 21 for connection to other radios.
- POWER SUPPLY...110-120 volts, 60 cycles, 10 watts.
- CABINET... Attractive brown bakelite cabinet of modern design. Width 11 $\frac{3}{4}$ " x depth 9 $\frac{7}{8}$ " x height 3".

Stock No. R-93F

Ask your distributor for special low price.

No. 33122—Crystal Cartridge for above...List **\$3.75**

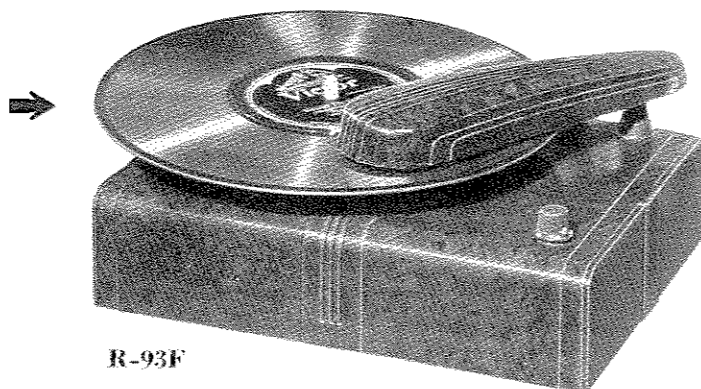

R-93F



VA-21

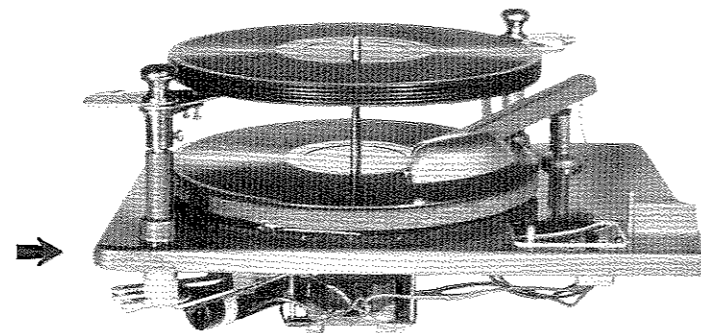

No. 9909D

- FINISH... Attractive smooth brown lacquer with chromium trim
- NEEDLE PRESSURE... 3 ounces
- POWER SUPPLY...110-120 volts, 60 cycles, 14 watts.
- DIMENSIONS... Motorboard 14 $\frac{3}{4}$ " wide by 11 $\frac{1}{2}$ " deep. Space required above motorboard 4 $\frac{1}{4}$ ".

List Price **\$34.95**

No. 35171—Crystal Cartridge for No. 9909D...List **\$4.25**

RCA VICTOR WIRELESS RECORD PLAYER MODEL VA-21

With this unique accessory you can play records through any radio without making a single connection. Not only does it give excellent reproduction—the same as obtained from a high-quality broadcasting station—but it may be located within a radius of 30 to 50 feet from the instrument with which it is being used. The feather-touch crystal pick-up and true-tracking tone arm insure minimum record wear while an RCA constant-speed motor eliminates "wows" and distortion. Has modulation type volume control with an on-off switch, adjustable output frequency and pilot lamp. Rich brown bakelite cabinet. 5" H. x 12 $\frac{9}{16}$ " W. x 8 $\frac{1}{4}$ " D.

Ask your distributor for special low price.

No. 33122—Crystal Cartridge for VA-21...List **\$3.75**

AUTOMATIC RECORD CHANGER

This improved RCA Automatic Record Changer plays seven 12-inch records or eight 10-inch records automatically and repeats the last record. A reject lever is incorporated which immediately feeds in the next record. Records of any size may be played manually. (Up to 12")

The mechanism is of a simple, fool-proof design and positive in operation. An important feature is the top loading crystal pick-up with an automatic needle ejector and receptacle. Whenever it is desired to remove a needle, the needle screw is merely loosened and the needle is dropped.

Proper design of the arm in which the needle is off-set to assure best tracking, together with proper needle pressure, insures minimum record wear.

SPECIFICATIONS

- AUTOMATIC OPERATION...Eight ten-inch or seven twelve-inch. Repeats last record until it is turned off. Operation of reject lever automatically changes to next record.
- MANUAL OPERATION...Plays any size record up to 12 inches
- PICK-UP IMPEDANCE...100,000 ohms at 1,000 cycles (1,300 mmf. over the range 70-7,000 cycles).
- OUTPUT...1.5 volts at 1,000 cycles with 500,000 ohm load

HOME RECORDER AND AUTOMATIC RECORD PLAYER

A real value in home entertainment, this instrument provides every feature of the Standard Record Changer, plus a high-quality crystal cutting head for recording purposes. Every part has been carefully designed to provide the user with the very best in recording equipment, plus the Automatic Record Changer for playing of standard 10" and 12" records. The crystal pick-up characteristics are identical with the No. 9909 Record Changer. Specifications for the recording head and heavy-duty motor are:

- CUTTER IMPEDANCE AT 1,000 CYCLES...60,000 ohms, approx.
- TURNTABLE SPEED...78 r.p.m.
- GROOVES CUT PER INCH...115, approx.
- INCHES CUT PER MINUTE...0.713, approx.
- RECORDING BLANK DISC... Coated metal or paper base.
- RECORDING DISC DIAMETER...Up to 10 inches.
- DRIVER SYSTEM... Motor-driven through idler on inside rim of turntable. Turntable spindle drives lead screw which guides recorder arm from outside to inside of recording blank.
- MOTOR... 105/125 volts, 60 cycles; power consumption, 35 watts.

No. 9910—Home Recorder and Automatic Record Player
List Price **\$59.50**

MANUAL MOTORBOARD ASSEMBLY

This really fine reliable motorboard and latest type crystal pick-up arm is designed specifically for modernization of old phonographs. The assembly makes it practical to convert any modern a-c radio into an electrical radio-phonograph combination. It is also well-suited for use in modernizing special sound-effects installations and custom-built equipment requiring the playing of single records. The motorboard is completely a-c operated (110-volts, 60 cycles). A feature of the instrument is its automatic "start-stop" switch which starts the motor when the pick-up arm is placed on the record—and stops the motor at the end of the record. The crystal pick-up is of the latest type with top needle loading; characteristics same as No. 9869. A needle cup and pick-up arm rest are included. No. 9908 Manual Motorboard is finished in light brown smooth lacquer. Blends with any cabinet finish. Has minimum space requirements beneath board. Overall width 14 $\frac{3}{4}$ "; depth 11 $\frac{1}{2}$ ". Power consumption 14 watts.

No. 9908—Complete with all mounting hardware and installation instructions...List Price **\$24.95**

No. 35171—Crystal cartridge for above...List Price **\$ 4.25**

SYNCHRONOUS REACTION MOTOR AND TURNTABLE

This new motor is used on many RCA Victor Combinations and Record Players. It has shock-proof mountings and is free from wows. This unit is simple in design and is practically wear- and trouble-free in operation. Turntable is finished in an attractive brown flock which blends with any cabinet finish. A soft rubber spindle cap prevents vibration pick-up by records. Turntable diameter, 7 inches. Plays any size record up to twelve inches in diameter. Consumes only 10 watts.

List Price **\$5.95**

Stock No. 33343

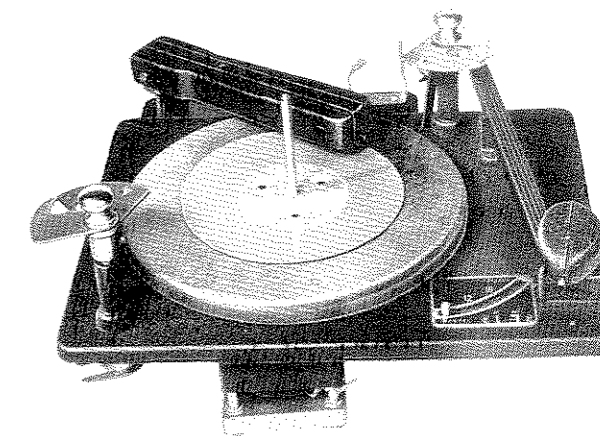

No. 9910

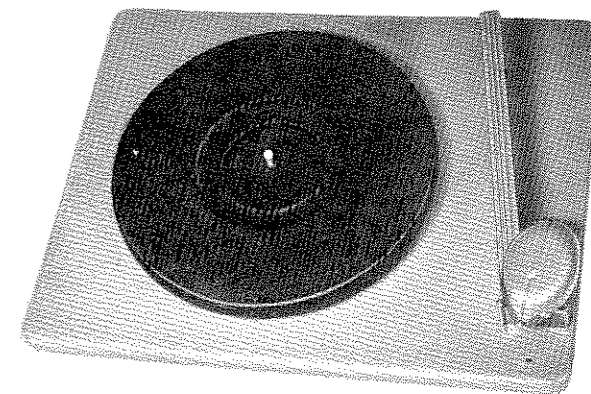

No. 9908

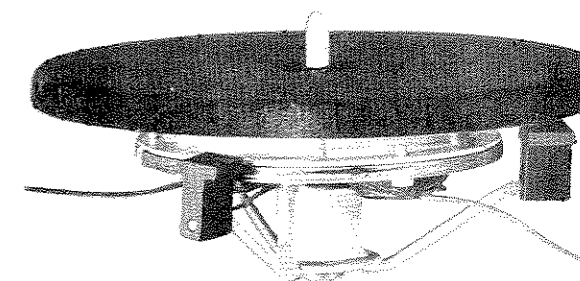

No. 33343

RCA PHONOGRAPH PICK-UP ARMS

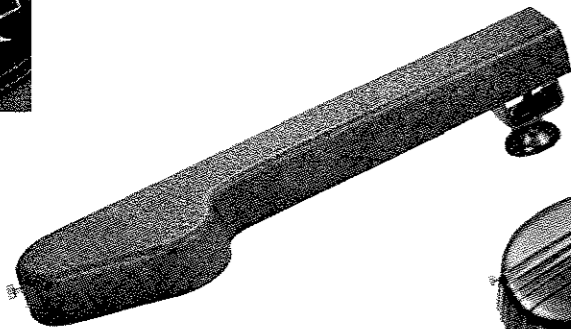

No. 9891

JUNIOR CRYSTAL PICK-UP

This pick-up has every important feature necessary for obtaining excellent fidelity of reproduction from records. It plays either 10" or 12" records, has a completely sealed crystal, and the needle position is offset to assure true tracking. A new feature is the use of viscaloid dampening. This gives improved reproduction and reduces needle chatter. Shock-proof mounting parts are included. Finished in brown wrinkle lacquer.

SPECIFICATIONS

- IMPEDANCE... 100,000 ohms at 1,000 cycles (1,300 mmf. over range 70-7,000 cycles).
- FREQUENCY RANGE... 70-7,000 cycles.
- OUTPUT VOLTAGE... 1.5 volts at 1,000 cycles with 500,000 ohm load.
- NEEDLE PRESSURE... 2.7 ounces.

List Price **\$4.95**

Stock No. 9891

33217—Crystal Cartridge for above..... List **\$3.75**

31050—Crystal Cartridge for No. 9842 Pick-Up..... List **\$3.75**

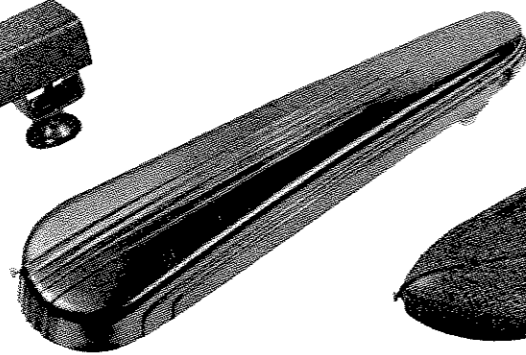

No. 9868

IMPROVED JUNIOR PICK-UP ARM

This new pick-up arm incorporates all the features of the older types but has an unusually attractive molded housing. Excellent fidelity of reproduction is obtained through the use of a sealed crystal pick-up and the arm may be used for either 10- or 12-inch records. Needle insertion is easy and shock-proof mounting parts are included. The polished brown finish blends with any type of cabinet.

SPECIFICATIONS

- IMPEDANCE... 100,000 ohms at 1,000 cycles (1,300 mmf. over range 70-7,000 cycles).
- FREQUENCY RANGE... 70-7,000 cycles.
- OUTPUT VOLTAGE... 1.5 volts at 100 cycles with 500,000 ohm load.
- NEEDLE PRESSURE... 2.7 ounces.
- FINISH... Polished moulded Bakelite.

List Price **\$5.45**

Stock No. 9868

33122—Crystal Cartridge for above..... List **\$3.75**

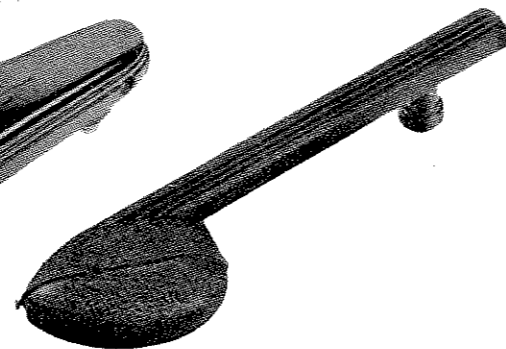

No. 9869

SENIOR CRYSTAL PICK-UP

Modern design plus top needle loading are outstanding features of this fine RCA Pick-up. With the Stock No. 33909 needle box, used needles are ejected by merely loosening the needle screw and pressing the needle box lever. New needles are inserted by placing them in the hole at the top, while the ejector functions as a needle positioning bracket. This is a sturdy, well-built pick-up and arm that gives unusually fine record reproduction. Recommend it to your most discriminating customers.

SPECIFICATIONS

- IMPEDANCE... 100,000 ohms at 1,000 cycles (1,300 mmf. over range 70-7,000 cycles).
- FREQUENCY RANGE... 70-7,000 cycles.
- OUTPUT VOLTAGE... 1.5 volts at 1,000 cycles with 500,000 ohm load.
- NEEDLE PRESSURE... 3 ounces.
- FINISH... Brown wrinkle lacquer.

List Price **\$6.45**

Stock No. 9869 (Less needle bracket)

Stock No. 33909 Needle Box and Pick-up Rest..... List Price **\$1.00**

35171—Crystal Cartridge for above..... List **\$4.25**

SENIOR PICK-UP ARM WITH AUTOMATIC SWITCH

Enjoy the advantages of both unusually fine record reproduction and of automatic off-on operation. This attractive and well-built modern combination consists of the famous RCA Senior Crystal Pick-up arm with its top needle loading and automatic ejection features, plus an automatically operated switch. Fool-proof switch starts the motor when the pick-up arm is placed on the record—stops the motor when the record is finished. All switch parts are concealed beneath the motorboard assembly. Characteristics of the pick-up arm are identical to No. 9869. Needle box and pick-up rest included with assembly.

No. 9911—Complete and with installation instructions..... List Price **\$7.95**

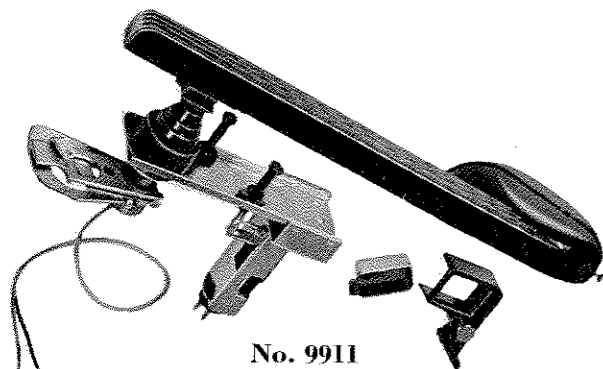

No. 9911

FOR MAGNETIC PICK-UPS AND ARMS, SEE PAGE 21

RCA ACCESSORIES

UNIVERSAL INTERSTAGE A-F TRANSFORMER

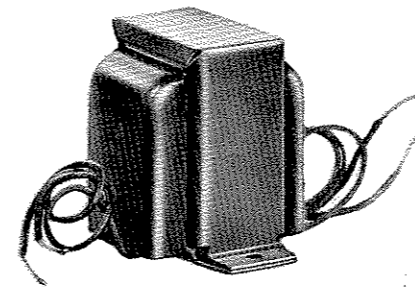

No. 9632

The RCA Interstage Transformer permits you to make all audio transformer replacements with a single unit. It contains a center tapped primary and a center tapped secondary for connecting either from or to any single or push-pull stage. Has proper step-up ratio and is easily mounted on any type of chassis. Also recommended to step up pick-up output for use with low gain amplifiers.

SPECIFICATIONS

- SIZE... 2" x 2 3/4" x 2 7/8". Shielded black finish case—vacuum wax impregnated.
- TURN RATIO... Primary to secondary 1:3 overall
- PRIMARY CURRENT... 10 milliamperes d. c. (Maximum).
- FREQUENCY RESPONSE... 30-10,000 cycles

- PRIMARY CONNECTIONS... Primary connects to any single or push-pull triode. Secondary, to any single or push-pull stage regardless of tube type.

List Price

\$2.00

Stock No. 9632

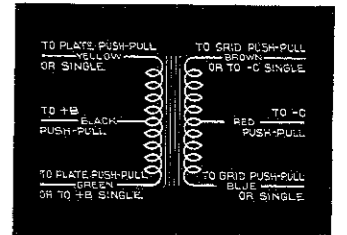

UNIVERSAL OUTPUT TRANSFORMERS

These output transformers fit any combination of tubes and speakers ordinarily encountered in service work. They are quickly mounted by means of slot angle brackets, have a silicon steel core and their windings are protected with a baked varnish impregnation. Tinned terminals and long primary leads make installation easy. Fit practically all output tubes and speakers.

SPECIFICATIONS

- VOICE-COIL IMPEDANCES... 1 to 15 ohms
- PRIMARY LOAD IMPEDANCES... 1,000 to 20,000 ohms.
- MAXIMUM WORKING POTENTIAL... 500 volts

- MAXIMUM PLATE CURRENT (each tube) 55 milliamperes.
- FREQUENCY RANGE... 30 to 10,000 cycles.
- SIZE... Standard Model—2 3/4" x 2 1/2" x 3". Tropical Model—2 3/4" x 2 3/8" x 3".

List Price

\$2.00

Stock No. 7852

SPECIAL TROPICAL MODEL

This is the same transformer in a special case having vacuum wax impregnated windings and complete potting in asphalt for use under the most severe climatic conditions.

List Price

\$2.35

Stock No. 7853

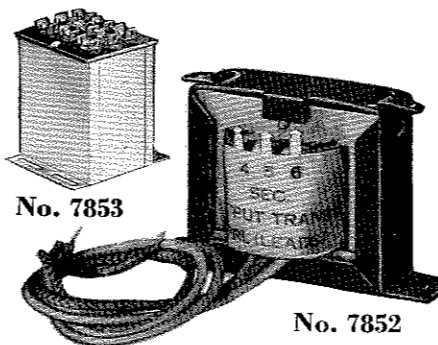
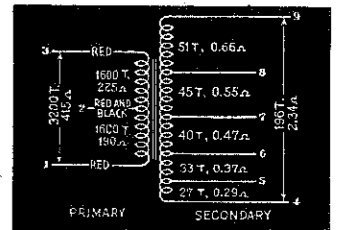

No. 7853

No. 7852

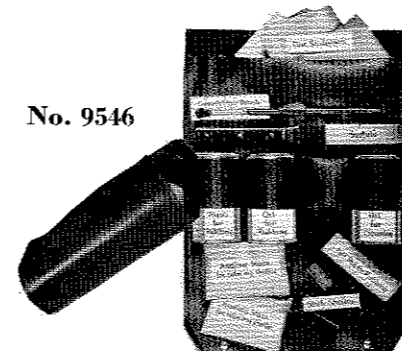

No. 9546

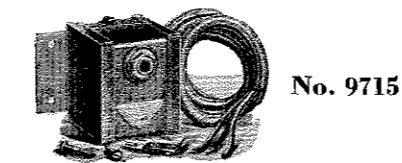

No. 9715



No. 108-109

RCA VICTOR CABINET REFINISHING KIT

Here is a kit that should be a part of every service engineer's equipment. Includes all essentials to perform any small touch-up job or a general cabinet cleaning that you may be called upon to perform. Attention to cabinet details is a sure way of selling yourself to your customers. Every customer appreciates a nice clean piece of furniture and you can sell this service for a good price if you have and use this kit.

CONTENTS:

- One each of the following—
Can Refco oil
Can rubbing oil
Assorted stick shellac
Spatula
Two packages of aniline stain powders
Instruction sheet

- The entire contents are packed in a durable leatherette case with snap buttons.
Can Tripoli
Assorted sandpaper
Touch-up brush
Rubbing block

Net Price

\$2.90

Stock No. 9546

RCA EARPHONE ADAPTOR

A handy unit for connecting hearing aids or headphones to any radio. Has three positions—one for radio alone, one for both earphones and radio, and one for earphones alone. Easily connected across voice coil and gives proper impedance match. Finished in attractive brown wrinkle lacquer and fitted with 36-inch cable and terminal block.

List Price

\$3.50

Stock No. 9715

RCA VICTOR SERVICE NOTES

These volumes of RCA Victor Service Notes cover the complete service information on all RCA Victor and RCA Service Test Equipment produced during 1938 and 1939. These books not only contain all of the wiring diagrams but also contain complete alignment instructions and other details available from no other source.

NOTE: Limited quantities on issues from 1923 to 1937 are still available but will not be reprinted after the supply is exhausted.

Stock No. 108—1938..... List Price **\$1.25**
Stock No. 109—1939..... List Price **1.50**

KINESCOPE DEFLECTING CIRCUIT PARTS

RCA has made available many of the component parts that are basic units for the construction of kinescope deflecting circuits. These parts have been developed by RCA engineers in accordance with proven scientific principles and are manufactured for long, efficient service. Typical schematic diagrams of deflection circuits using these parts will be furnished on request.

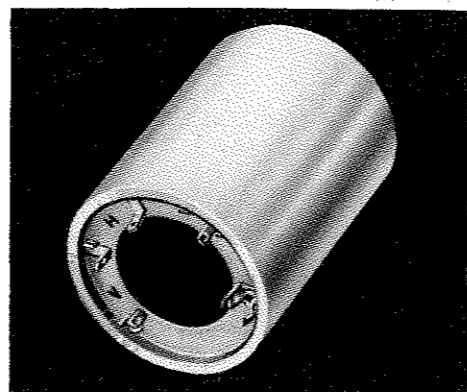

PARTS FOR USE WITH RCA 9- AND 12-INCH MAGNETIC DEFLECTION KINESCOPIES RCA TYPES 9AP4/1804P4 AND 12AP4/1803P4

STOCK NO. 9857	YOKE Has windings for horizontal and vertical deflecting circuits. Designed for uniform flux distribution. Vertical coil inductance..... 45 MH (45 ohms) Horizontal coil inductance..... 1.5 MH (5 ohms) One vertical coil has 5,600-ohm resistor connected in parallel to counteract transient waves from horizontal coil. List Price \$17.50	STOCK NO.	Primary d-c resistance..... 670 ohms Secondary d-c resistance..... 135 ohms Ratio..... 4.16:1 List Price \$1.75
9861	HIGH-VOLTAGE POWER TRANSFORMER Primary..... 117 volts Rectifier Filament Winding..... 2.5 volts, 5 a. Secondary High-Voltage Winding..... 7,000 volts, 0.002 a. List Price \$22.50	32899	HORIZONTAL OSCILLATION TRANSFORMER Designed for high-frequency blocking-oscillator circuit. High efficiency at 13,200 cycles. Primary d-c resistance..... 3.5 ohms Secondary d-c resistance..... 8.55 ohms Ratio..... 1:2 List Price \$1.75
9862	HORIZONTAL OUTPUT TRANSFORMER Has correct characteristics to supply a 13,200-cycle, saw-tooth current wave to deflecting yoke. Core and coil rubber-mounted to eliminate noise. Primary d-c resistance..... 13.2 ohms Secondary d-c resistance..... 0.825 ohms Ratio..... 5.78:1 List Price \$17.50	32900	VERTICAL OUTPUT TRANSFORMER Primary d-c resistance..... 1,122 ohms Secondary d-c resistance..... 8 ohms Ratio..... 15.95:1 List Price \$5.50
32898	VERTICAL OSCILLATION TRANSFORMER Designed for low-frequency blocking-oscillator circuit. Most efficient at 60 cycles. Primary d-c resistance..... 670 ohms Secondary d-c resistance..... 135 ohms Ratio..... 4.16:1 List Price \$1.75	33018	HIGH-VOLTAGE FILTER CAPACITOR—With Bracket (2 required) 0.03 mf. at 7,500 volts. Oil-filled, fireproof, dielectric material has long life. List Price \$3.75
		32815	12" Mask for 12AP4/1803P4 Kinescope..... List Price \$2.40
		32019	9" Mask for 9AP4/1804P4 Kinescope..... List Price 1.90

PARTS FOR USE WITH RCA FIVE-INCH ELECTROSTATIC-DEFLECTION KINESCOPE RCA 5BP4/1802P4

STOCK NO. 32898	VERTICAL OSCILLATION TRANSFORMER Designed for low-frequency blocking-oscillator circuit. Most efficient at 60 cycles. Primary d-c resistance..... 670 ohms Secondary d-c resistance..... 135 ohms Ratio..... 4.16:1 List Price \$1.75	STOCK NO.	Ratio..... 1:2 List Price \$1.75
32899	HORIZONTAL OSCILLATION TRANSFORMER Designed for high-frequency blocking-oscillator circuits. High efficiency at frequency of 13,200 cycles. Primary d-c resistance..... 3.5 ohms Secondary d-c resistance..... 8.55 ohms	33020	TWO SECTION HIGH-VOLTAGE FILTER CAPACITOR—With Bracket One section..... .15 mf. at 2,500 volts One section..... .05 mf. at 3,000 volts List Price \$2.65
		33120	LOW-VOLTAGE REACTOR 8 Henries at 0.14 amp., d-c. D-c resistance..... 315 ohms List Price \$3.25

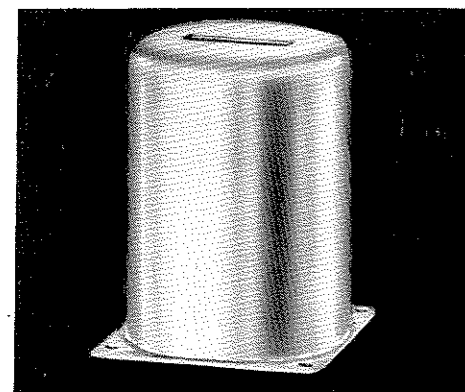

STOCK NO. 33190	THREE-SECTION ELECTROLYTIC FILTER CAPACITOR Two Sections..... 30 mf. at 450 volts One Section..... 10 mf. at 150 volts List Price \$2.50
33211	HIGH-VOLTAGE RECTIFIER SOCKET—4 prong Molded of Bakelite. Eliminates corona and ionization—constructed with ample space between plate terminals and ground to prevent high-voltage breakdown. Designed to prevent dust collecting over contacts. List Price \$1.00
33340	HORIZONTAL COUPLING CAPACITOR (2 required) 0.005 mf. at 3,000 volts. Long life—withstands high humidity. List Price 0.50
33341	VERTICAL COUPLING CAPACITOR (2 required) 0.05 mf. at 3,000 volts. Withstands high humidity—has long life. List Price 0.50
33390	POWER TRANSFORMER Primary, 117 volts. Secondaries: Low Voltage Plate..... 660 V. (330 each side), 0.14 A. High Voltage Plate..... 2,240 V., 0.002 A. Low Voltage Windings..... 6.6 V., 0.3 A.; 6.3 V., 0.6 A.; 5.0 V., 3.0 A.; 2.5 V., 1.75 A.; 12.6 Volt (6.3 each side), 3.82 A. List Price \$13.50

No. 9824-A

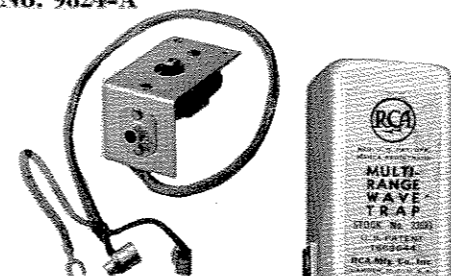

No. 33033

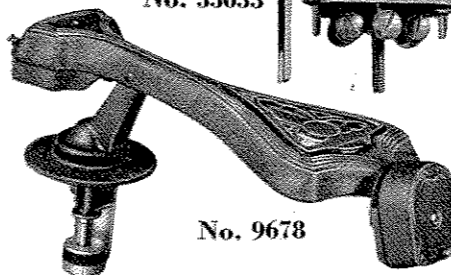

No. 9678

NEW RECORD-PLAYER SWITCH AND CONNECTOR

This new, easily-installed switch is used for connecting RCA Victor Record Players, or almost any other type of phonograph turntable, to a radio receiver so that the listener may quickly change from radio to record reproduction. Any one can install it. Switch suppresses radio when turned to "record" position—provides improved performance because it maintains and isolates original bias and other d-c voltages in the receiver circuit. The majority of installations can be made without removing the receiver chassis from its cabinet, without need for soldering. Includes sufficient length of shielded cable, knob and mounting screws.

No. 9824-A	New Record Player Switch and Connector, complete with installation instructions.....	List Price \$1.15
No. 9824	Standard Record Player Connecting Switch and Cable.....	List Price 1.00 (Limited quantities available)

OSCILLOGRAPH CONNECTING CABLES

For connecting between your oscillograph, test oscillator and radio chassis, you need low capacity shielded cables with handy connecting clips. The Stock No. 9797 assembly consists of three shielded cables designed especially for this use and is a necessity for everyone using the oscillographic method of alignment.

Net Price **\$1.50**
Stock No. 9797

RCA MULTI-RANGE WAVE TRAP

For those receivers and locations that are troubled by unwanted interference or inadequate reception of certain stations, the RCA Multi-Range Wave Trap will be found the logical answer. This new unit is tuned by means of a magnetite core which provides a simple linear and permanent adjustment. Attenuation at tuning frequency 40-1 (average) over entire broadcast band! Frequency Range 450 kc. to 2,100 kc. The RCA Multi-Range Wave Trap is adequately shielded for protection against interference and reaction with receiver circuits. Its small size and simple mounting make it easy to install.

List Price **\$1.85**
Stock No. 33033

MAGNETIC PICK-UPS AND ARM

INERTIA-TYPE SUSPENSION ARM

These RCA Magnetic Pick-ups and Inertia Type Arm are the finest units of this type available. The pick-ups use viscoloid damping blocks to assure undistorted reproduction, while the design of the arm gives excellent frequency response. An improved type of rubber mounting prevents vibration pick-up from the motor; a shielded lead permits noise-free connections to the input circuit. These pick-ups and arm are furnished in a variety of impedances and finishes. Select the one that is best suited for your requirements. You are assured of the finest in magnetic pick-up design.

MAGNETIC PICK-UP HEADS

Stock No.	List Price	Finish	Impedance at 1,000 cycles	Output Voltage at 400 cycles
9661	\$6.50	Walnut	8.5	.038
9665	6.50	Walnut	30	.083
9676	6.50	Black	400	.285
9669*	6.50	Walnut	700	.46
9670	6.50	Walnut	2,800	.65
9675	6.50	Black	8,500	1.21
9749	6.50	Walnut	8,500	1.21

*Viscoloid Damping not included.

INERTIA-TYPE SUSPENSION ARM

No. 9678 Inertia Suspension Arm includes a plain escutcheon and a plug for connecting to the magnetic pick-up. Fits any of the pick-ups listed above. Finished in walnut.

No. 9678..... List Price **\$7.50**

REPLACEMENT PARTS GUIDE

The following index is supplementary to the "Replacement Parts Guide" published in the previous issue of this catalog and covers parts for RCA Victor instruments marketed since that time. The parts listed are exact replacements and may be purchased from RCA Parts Distributors. For prices refer to your RCA Victor Parts Distributor.

RCA Victor Model	Antenna Coil	R.F. or Detector Coil	Oscillator Coil	1st I.F. Trans.	2nd I.F. Trans.	Output Trans.	Cone	Volume Control	Tone Control	Power Trans. (110 V.-60 Cy.)	Filter Pack Or High Voltage Capacitor
4QB	32821 (A, B, C)		32148 (A) 33784 (B) 33785 (C)	32263	32825	33805	33804	33780		33783	33810
4QB4	32706 (X)		33787 (C) 33786 (X)	14261	32825	33805	33804	33780		33783	33810
6QK8	32822 (A, C) 32823 (X)		32707 (A, C) 32931 (X)	14376	32825	14355	31275	33533	33533	32911	32240
7Q4	33762 (A, B, C) 32823 (X)	33763 (A, B, C) 33765 (X)	33764 (A, B, C) 32931 (X)	33759	33761	14355	34615	34389	34403	31735	33014
7Q4X	33762 (A, B, C) 32823 (X)	33763 (A, B, C) 33765 (X)	33764 (A, B, C) 32931 (X)	33759	33761	14628	35193	35187	34403		35188

REPLACEMENT PARTS GUIDE (Continued)

RCA Victor Model	Antenna Coil	R.F. or Detector Coil	Oscillator Coil	1st I.F. Trans.	2nd I.F. Trans.	Output Trans.	Cone	Volume Control	Tone Control	Power Trans. (110 V.-60 Cy.)	Filter Pack Or High Voltage Capacitor
7QB	31780	31781	32824	14261	14283	32368	35193	31776	31777	31998	32152
7QBK	31780	31781	32824	14261	14283	32368	31275	31776	31777	31998	32152
7QK4	33762 (A, B, C) 32823 (X)	33763 (A, B, C) 33765 (X)	33764 (A, B, C) 32931 (X)	33759	33761	14355	31275	34389	34403	31735	33014
8QU5C } 8QU5M }	33762 (A, B, C)	33763 (A, B, C)	32824 (A, B, C)	32263	14308	14534	34274	33814		31733	
9Q1	34647—(B, 31) 34648—(25, 19, 16, 13) 34649—(A)	34650—(B, 31) 34651—(25, 19, 16, 13) 34652—(A)	31782 (A) 34659 (B) 34661—13 meter bands 34657—16—19 meter bands 34658—25 meter bands	32263	14308	14534	34615	34667	34666	31733	33014
9Q4	33762 (A, B, C) 32823 (X)	33763 (A, B, C) 33765 (X)	33764 (A, B, C) 32931 (X)	33759	33761	14534	34615	34389	34595	34183	34393
9QK	34647—(B, 31) 34648—(25, 19, 16, 13) 34649—(A)	34650—(B, 31) 34651—(25, 19, 16, 13) 34652—(A)	31782 (A) 34659 (B) 34661—13 meter bands 34657—16—19 meter bands 34658—25 meter bands	32263	14308	14534	31275	34667	34666	31733	33014
9TX50 (RC454)			34443	34441	34442	34174	35065	33291			34597
U9 (RC482B) (RC482C)	Spkr. No. RL81-2 Spkr. No. 84843-1 Spkr. No. RL81A-3		34443	34844	34442	34846 34848 35904	34554 34847 35570	34034			34873
U10	33775		33724	33722	33895	32905	32904	33776		33112	32342
U20			32707	33263	34719	33444	34705	34721		34261	32240
40X52 (RC453)			34443	34441	34442	34174	35065	32545			34597
40X55 (RC453)			34443	34441	34442	35056	35066	32545			34597
CV40										34559	32826
U40			32707	32263	34719	33444	34705	34721		34261	32240
BK41	32150		32148	14261	14308	34386	34385	34557			
BT41	32150		32148	14261	14308	32164	32163	30947			
BK42	32150		32573	34118	34119	34508	34507	34120	33458		12635
U42			32707	32263	34719	33444	34705	34721		34261	32240
U43			32707	32263	34719	33444	35616	34721	35738	34261	32240
U44		34697	34579	34698	34524	14534	34705	34780		34539	34533
45X1 (RC457)	35115		35116	35114	33301	34846	35120	35113			32576
45X1 (RC457A)	35115		35333	35331	33301		35120	35330			32576
45X2 (RC457)	35115		35116	35114	33301	34846	35120	35113			32576
45X2 (RC457A)	35115		35333	35331	33301	34846	35120	35330			32576
45X5 } 45X6 }	35115		35337	32966	34442	34174	35120	35113			32576
45X11 Spkr. No. 39223-2 Spkr. No. RL86-2 (RC459)			34443	35054	35055	34174 35056	35065 35066	35057			32576
45X11 Spkr. No. 39223-2 Spkr. No. RL86-2 (RC459D)			35579	35346	35347	34174 35056	35065 35066	35344			35348
45X12 Spkr. No. 39223-2 Spkr. No. RL86-2 (RC459)			34443	35054	35055	34174 35056	35065 35066	35057			32576
45X12 Spkr. No. 39223-2 Spkr. No. RL86-2 (RC459D)			35579	35346	35347	34174 35056	35065 35066	35344			35348
45X13 Spkr. No. 39223-2 Spkr. No. RL86-2 (RC459A)			34443	35054	35055	34174 35056	35065 35066	35057			32576

REPLACEMENT PARTS GUIDE (Continued)

RCA Victor Model	Antenna Coil	R.F. or Detector Coil	Oscillator Coil	1st I.F. Trans.	2nd I.F. Trans.	Output Trans.	Cone	Volume Control	Tone Control	Power Trans. (110 V.-60 Cy.)	Filter Pack Or High Voltage Capacitor
45X13 Spkr. No. 39223-2 Spkr. No. RL86-2 (RC459E)			35579	35346	35347	34174 35056	35065 35066	35344			35348
45X111 } 45X112 } 45X113 }			35571	35346	35347	34174 35056	35065 35066	35344			35348
U45		34697	34579	34698	34524	14534	35616	34780	35686	34539	34533
46X1 Spkr. No. 39223-2 Spkr. No. RL86-5 (RC459B)			34443	35054	35055	34174 35056	35065 35066	35057			35064
46X1 Spkr. No. 39223-2 Spkr. No. RL86-5 (RC459F)			35571	35346	35347	34174 35056	35065 35066	35344			35348
46X2 Spkr. No. 39223-2 Spkr. No. RL86-5 (RC459B)			34443	35054	35055	34174 35056	35065 35066	35057			35064
46X2 Spkr. No. 39223-2 Spkr. No. RL86-5 (RC459F)			35571	35346	35347	34174 35056	35065 35066	35344			35348
46X3 Spkr. No. 39223-2 Spkr. No. RL86-5 (RC459C)			34443	35054	35055	34174 35056	35065 35066	35057			35064
46X3 Spkr. No. 39223-2 Spkr. No. RL86-5 (RC459H)			35571	35346	35347	34174 35056	35065 35066	35344			35348
46X11 } 46X12 } 46X13 }	Spkr. No. 39223-4 Spkr. No. RL86-4	35090	31296 (A) 35251 (B)	35054	35055	35056	35065 35066	35086			32576
46X21 } 46X23 } 46X24 }	35713 (C) 35661 (C)		35714 (A, C) 35667 (A, C)	35088	35089	35666*	35569	35086			35673
U46		34697	34579	34698	34524	12568	14602	35023	35022HF 35026LF	35027	35017 35016
K50 (RC497)			33724	32263	34719	33779	31275	34796	33634	33112	32240
BP55			34877	34466	34466	34555	34554	34465			34965
X55			33724	33722	34026	34803	34554	33631			34212
BP56			34877	34466	34466	34555	34554	34465			34965
T56			33724	33722	33723	32905	32904	33631		33112	32342
K60 (RC415B)			34579	14376	32825	31301	31275	34695	34578	33112	32240
X60	33732		33733	33722	34026	34803	34554	33631			
K61			32707	32263	34524	31301	31275	33215		33112	32240
K62			34579	32068	32825	31301	31275	34695	34578	33112	32240
T63			32707	32263	34719	32905	35441	35585		35587	32240
T65	32821		32824	33428	14308	32905	32934			33112	32240
K80 (RC415C) K80 (RC415D) K81			34579	14376	32825	33444	31275	34695	34578	33112	33014
K82			34579	32068	32825	33444	31275	34695	34578	33112	33014
BP85			34877	34466	34466	34555	34554	34465			34965
94BP61 (RC407B) 94BP62 (RC407B) 94BP64 (RC407B) 94BP66 (RC407B)			33055	33301	33302	33062					33303
96X5	31378		34452	34453	32534			32545			34460
K105		34697	34579	34698	34524	14534	34773	34695	34578	34539	34533
110-K } 111-K }	35965 "C" & 31 meter		35789	35636	35790	36144	36145	35962	35963	36044	36045
K130		34697	34579	34698	34524	12568	14602	35023	35022HF 35026LF	35027	35017 35016

*Combined with a-f transformer.

NOTE—Refer to previous issue of "Guide" and make following correction—Model C8-19, and C8-20 Volume Control should read Stk. No. 11237.

RCA TRANSMITTING-TUBE SOCKETS

The UT-102-A, UT-541-A and UR-542-A are rugged, dependable transmitting tube sockets of the bayonet lock type. High-quality materials have been selected to meet the rigorous requirements of transmitting service. The base of each socket is of white, glazed procelain, having high dielectric properties and low moisture absorbing characteristics. Socket contacts are phosphor-bronze and cadmium plated to insure positive connection at all times. The shell is nickel-plated and will hold the tube solidly in any mounting position.

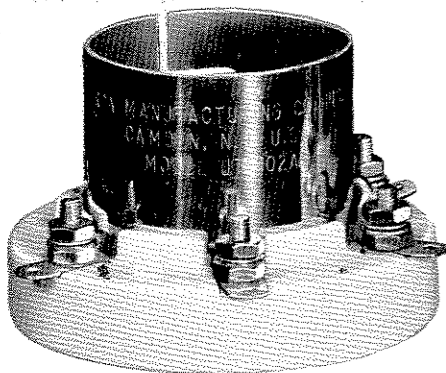

UT-102-A

A five-contact socket for RCA-803. Maximum diameter of base, 3 3/4 inches.

Net Price
\$1.50

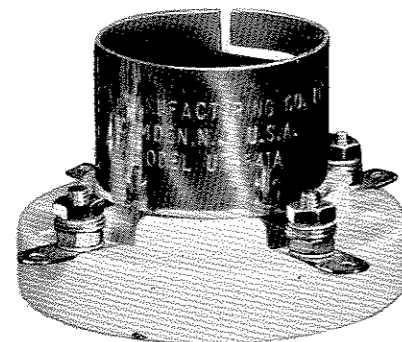

UT-541-A

A four-contact socket for RCA-810, RCA-806, RCA-872, RCA-203-A, etc. Maximum diameter of base, 3 3/8 inches.

Net Price
\$.75

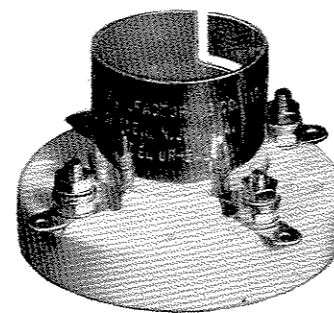

UR-542-A

A four-contact socket for RCA-866, RCA-866-A, RCA-811, RCA-812, RCA-809, RCA-834, etc. Maximum diameter of base, 2 13/16 inches.

Net Price
\$.50

SOCKET FOR TWIN-BEAM RCA-829 AND RCA-832

(WITH R-F BY-PASS CONDENSERS)

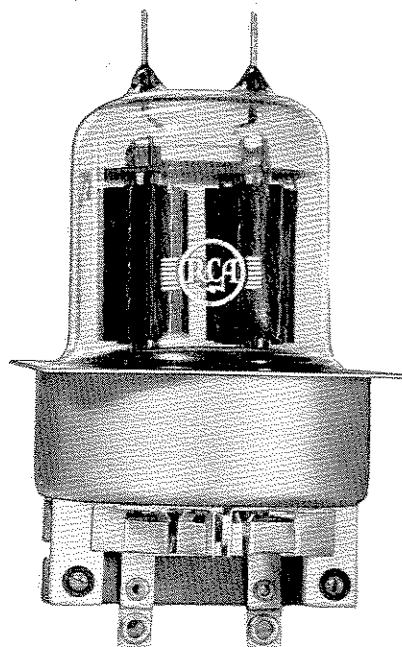

Socket with Tube in Position

The UT-107 Socket is a new design for use with the RCA 829 and 832 Twin R-F Beam Transmitting Tubes. This socket is recommended where these tubes are used in circuits operating above 60 megacycles. The UT-107 Socket has "built-in" r-f by-pass condensers for the heater and screens so that the shortest possible r-f path is obtained to place these elements at r-f ground potential. To obtain rated output and efficiency at maximum operating frequency of the RCA 829 and 832 it is essential to use the UT-107 Socket.

The use of glazed Steatite and Micalex insulation gives unusually low dielectric losses. The wiper contacts are of beryllium copper with heavy silver plate to insure a positive contact at all times. Marking provided for key pin location.

Chassis hole 2 9/16 inches in diameter.

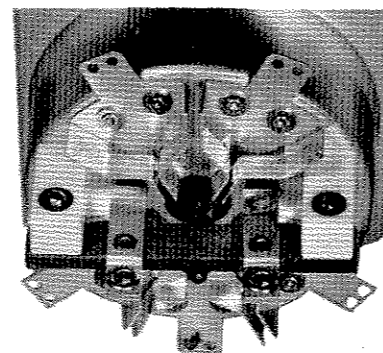

Bottom View of Socket Showing R-F By-Pass Condensers

UT-107

Net Price **\$6.95**

RCA TRANSMITTING-TUBE SOCKETS

RCA-813 SOCKET

The UT-104 is a square wafer socket especially designed for the RCA-813 Beam Power Amplifier. Low-loss Steatite insulation; low surface leakage; low dielectric losses. Top of socket is glazed, bottom waxed to prevent losses due to climatic conditions. Pincer type, cadmium-plated contacts have positive spring tension. Finder ring facilitates locating proper tube pins. Requires a chassis hole 2 1/4 inches in diameter for mounting.

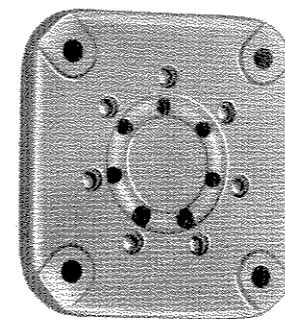

UT-104

For RCA-813

Net Price **\$.75**

SOCKET FOR TWIN-BEAM RCA-829 AND RCA-832

The UT-106 is a square wafer socket designed for the RCA-829 and RCA-832 Twin-Beam Transmitting Tube. Recommended for use below 60 Mc or for audio frequency applications. (See UT-107 for higher frequencies). The base is of glazed Steatite which insures a minimum of dielectric loss. The top of the socket is glazed and the bottom is waxed to prevent moisture absorption. The contacts are pincer type, cadmium plated. An aluminum shielding ring attaches to the socket and extends upwards 3/4 of an inch around the base of the tube. A chassis hole 2 1/4 inches in diameter is required for mounting.

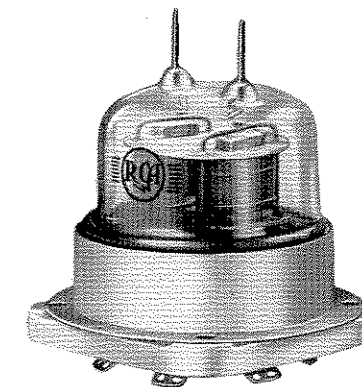

UT-106

Net Price **\$1.05**

250-WATT TYPE MOUNTINGS

These two familiar end mountings, the UT-1085 and UT-1086, have been accepted standard for many years as the ideal mounting for the RCA-204-A, RCA-831, RCA-849, RCA-851, RCA-861, RCA-869-A and similar tubes. Thousands in everyday use. Insulation is white glazed porcelain insuring good dielectric properties and freedom from climatic effects. The spring contacts are cadmium-plated to give positive connection. Can be mounted horizontally or vertically.

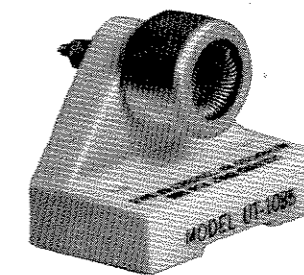

UT-1085

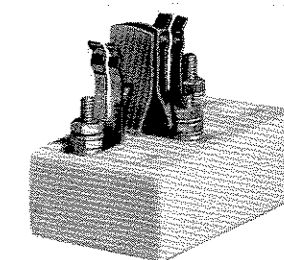

UT-1086

**UT-1085
UT-1086**

Net Price
\$4.65
Per Pair

RCA-833 MOUNTING ASSEMBLY

This fine UT-103 mounting assembly consists of one MI-7477 filament-terminal connector and two MI-7478 grid/plate post connectors. MI-7477 is polarized to permit one-way insertion only of tube in mount. The filament-terminal posts and knurled set-screw knobs are chromium plated and mounted on a white glazed Steatite base. MI-7478 grid/plate connector, with its flanged radiator, provides large-surface contact. It will quickly dissipate the heat generated at grid and plate terminals. The MI-7478 is supplied with flexible copper strips for connection to circuit parts.

UT-103 Complete for RCA-833 and RCA-833-A (includes one MI-7477 and two MI-7478's). Net Price **\$7.50**

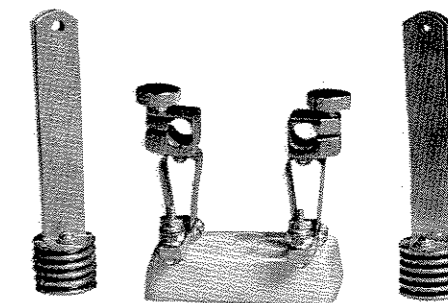

UT-103
Mounting
Assembly

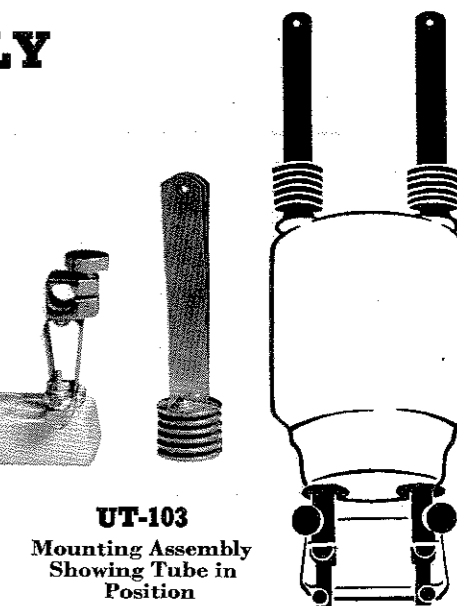

UT-103
Mounting Assembly
Showing Tube in
Position

AR-77 COMMUNICATION RECEIVER

AN ADVANCE IN RECEIVER DESIGN FOR AMATEUR AND GENERAL COMMUNICATION SERVICES

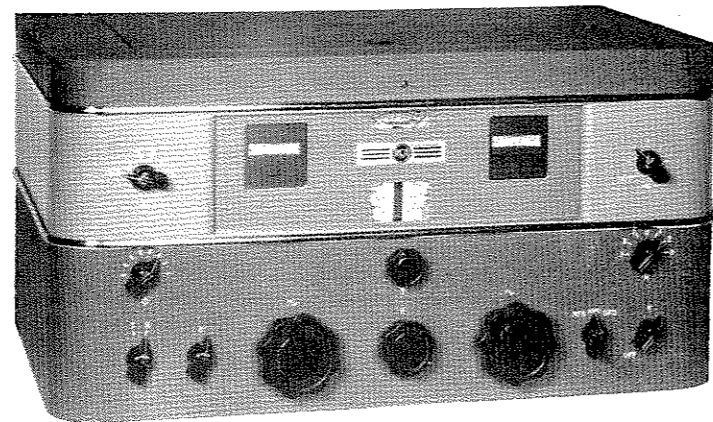

The famous 10-tube AR-77 is one of the finest receivers ever offered for communication applications. It has all the worthwhile features essential for reliable operation under the most severe conditions. Frequency coverage is 540 to 31,000 kc. in six ranges with individual coils for each band. Band switching is employed. In the AR-77, RCA engineers have gone the limit in designing a receiver that provides the utmost in signal-getting ability, noise-free operation, stability, convenience of tuning, and economy.

High sensitivity, extreme frequency stability, and razor edge selectivity are but a few of the outstanding features that make this receiver a leader. Accurately calibrated 270° dials for the main-tuning and band-spread controls make it easy to find stations of known frequencies and to locate signals for future reference.

FEATURES

- HIGHEST SIGNAL-TO-NOISE RATIO... 2-to-1 ratio obtained at an average sensitivity of 2 microvolts. Builds up weak signals ordinarily lost in receiver background noise.
 - "STAY-PUT" TUNING... Only 3 kc. drift (within audio range) in one-hour run on 30 Mc.
 - ADJUSTABLE NOISE LIMITER... Extremely effective on ignition or similar type of interference.
 - VARIABLE SELECTIVITY THROUGH USE OF CRYSTAL FILTER... Adjustable in six steps from 6 kc. to 80 cycles!
 - IMPROVED IMAGE REJECTION... Image ratio at 30 Mc. approximately 40-to-1 with a 50-ohm load input; 20-to-1 with a 300-ohm input.
 - "BREAK-IN" OPERATION... Used on a separate antenna, receiver recovers instantly when transmitter key is up.
 - UNIFORM SENSITIVITY... Dual r-f alignment with air-dielectric trimmers and inductance adjustment assure stable alignments and perfect "tracking" of r-f amplifier, 1st detector, and high-frequency oscillator circuits for maximum sensitivity and selectivity.
 - POLYSTYRENE INSULATION is used for high efficiency 10- and 20-meter coil forms.
 - HIGH QUALITY AUDIO OUTPUT... Negative feedback in a-f amplifier smooths out and extends the audio response curve.
- Other PLUS Features: Antenna Trimmer to provide peak tuning of input circuit at all times; Carrier-Level Meter calibrated in 6-db. steps to "S9" and to 40-db. beyond; Effective Automatic Volume Control; Magnetite Core I-F Transformers; Tropic treatment of Insulation; Special "stand-by" switch for inter-connected transmitter control.
- SPECIFICATIONS: Dimensions... 20 1/2" long x 11 1/2" deep x 10 1/2" high. Modern styling. Durable two-tone gray finish with polished metal trim. Receiver available with either 105-125 volt, 50/60 or 25-cycle power supply. Shipping weight, 57 lbs.

AR-77 Communication Receiver 105-125 volt 50/60 cycle (MI-8302-D).....	\$139.50
AR-77 Communication Receiver 105-125 volt 25 cycle (MI-8302-F).....	150.00
AR-77 Communication Receiver for Rack Mounting (MI-8302-G).....	150.00
Eight Inch P. M. Speaker for Rack Mounting (MI-8303-A).....	15.00
Eight Inch Table Speaker in Matched Cabinet (MI-8303).....	8.00
AR-77 Communication Receiver (MI-8302-D) and MI-8314, walnut cabinet loudspeaker.....	159.50
AR-77 Communication Receiver (MI-8302-D) and umber gray cabinet loudspeaker MI-8314-A.....	154.50
MI-8308 Power Supply Pack for 6-volt operation.....	29.50
MI-8307-2 Power Pack for 110-volt d-c operation.....	49.50
MI-8307-3 Power Pack for 220-volt d-c operation.....	49.50
MI-4904 Audio Coupling Transformer for 500 ohm line.....	On application

EXTENDED-RANGE LOUDSPEAKER

Supplementing the high quality audio output of the AR-77 is the MI-8314 Extended-Range Loudspeaker. This speaker has a uniform frequency response of 60 to 5,000 cycles to match electrically the audio output of the AR-77. The cabinet is of beautiful walnut finish and harmonizes with practically any interior furnishings. Cabinet dimensions: 24" wide x 14 1/2" deep x 32" high. Shipping weight, 55 lbs.

The Extended-Range Loudspeaker is also available in plain cabinet of smooth umber gray finish at slightly reduced cost. Cabinet size is 28" high, 18 3/4" wide and 13" deep. Is ideal in combination with the AR-77 for amateur installations where high-quality reproduction of modulated signals is desired without elaborate cabinet styling.

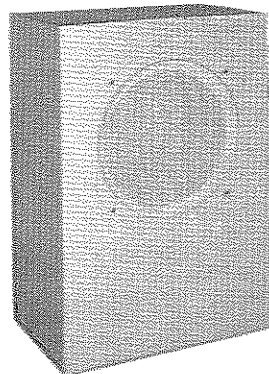

TRANSMITTING AND SPECIAL-PURPOSE TUBES

... FOR PERFORMANCE PLUS!

RCA Transmitting and Special-Purpose Tubes conform to the most exacting specifications. Components such as filaments, grids, anodes, and bases are carefully chosen for best results in terms of trouble-free performance and minimum overall cost to customer. Every tube is scrupulously tested during its manufacture. RCA Transmitting and Special-Purpose Tubes cost less per hour of service. Rely on them for absolute dependability.

TRANSMITTING TUBES

No.	Type	Max. Input	Amateur Net Price
203-A	Triode	220 Watts	\$10.00
211	Triode	220 Watts	10.00
800	Triode	100 Watts	10.00
801-A	Triode	42 Watts	3.45
802	Pentode	33 Watts*	3.50
803	Pentode	350 Watts	28.50
804	Pentode	150 Watts*	15.00
805	Triode	315 Watts	13.50
806	Triode	1000 Watts*	22.00
807	Beam	75 Watts*	3.50
808	Triode	200 Watts	7.75
809	Triode	100 Watts*	2.50
810	Triode	620 Watts*	13.50
811	Triode	225 Watts*	3.50
812	Triode	225 Watts*	3.50
813	Beam	360 Watts	22.00
828	Beam	270 Watts*	17.50
829	Twin Beam	120 Watts	19.50
833-A	Triode	2000 Watts*	85.00
834	UHF Triode	125 Watts	12.50
837	Pentode	32 Watts	7.50
838	Triode	220 Watts	11.00
845	Triode	150 Watts	10.00
1623	Triode	100 Watts*	2.50
1624	Beam	54 Watts	3.50
1628	UHF Triode	50 Watts	32.00

*ICAS rating. In CCS, tube is operated at somewhat lower ratings.

HALF-WAVE MERCURY-VAPOR RECTIFIERS

No.	Max. Ratings	Amateur Net Price
866	7500 Volts, 0.25 a.....	\$ 1.50
866-A	10,000 Volts, 0.25 a.....	2.50
872	7500 Volts, 1.25 a.....	9.00
872-A	10,000 Volts, 1.25 a.....	11.00

TELEVISION TUBES

No.	Description	Amateur Net Price
3AP4/906P4	3" Kinescope.....	\$18.25
5AP4/1805P4	5" Kinescope (Short Bulb).....	27.50
5BP4/1802P4	5" Kinescope.....	27.50
7AP4	7" Kinescope.....	36.00
1847	Amateur Iconoscope.....	24.50
1898	3" Monoscope.....	24.00
2V3-G	Half-Wave, High-Vacuum Rect. (16,500 Volts, 0.012 a.).....	3.00
878	Half-Wave, High-Vacuum Rect. (20,000 Volts, 0.020 a.).....	11.00

TELEVISION TUBES (continued)

No.	Description	Amateur Net Price
884	Gas Triode 6.3 v. Heater.....	\$ 2.00
885	Gas Triode 2.5 v. Heater.....	2.00

CATHODE-RAY TUBES

No.	Screen	Amateur Net Price
3AP1/906P1	3" Green Phosphor.....	\$13.50
5BP1/1802P1	5" Green Phosphor.....	24.75
902	2" Green Phosphor.....	7.50
908	3" Blue Phosphor (Short Bulb).....	18.00
913	1" Green Phosphor.....	4.00

PHOTOTUBES

No.	Description	Amateur Net Price
868	Gas Type.....	\$ 3.70
917	Vacuum type, Anode cap.....	4.75
918	Gas type, High Sensitivity.....	4.50
919	Vacuum type, with cath. cap.....	4.75
920	Twin Unit, Gas type.....	5.25
921	Cartridge, Gas type.....	2.00
922	Cartridge, Vacuum type.....	2.00
923	Gas type, 3 1/2" long.....	2.60
924	Gas type, Screw base.....	2.00
925	Vacuum type, 2 1/2" long.....	2.00
926	Cartridge, Vacuum type.....	3.00
927	Miniature, Gas type.....	3.70
928	Gas type, Non-directional.....	2.00
929	Vacuum type, High Sensitivity.....	3.00

U-H-F ACORN TUBES

No.	Description	Amateur Net Price
954	Pentode Amplifier, Detector.....	\$ 5.00
955	Triode Detector, Oscillator.....	3.00
956	Pentode, Super-Control Amp.....	5.00
957	Triode, 1.25 v., 0.05 a. fila.....	3.00
958	Triode, 1.25 v., 0.1 a. fila.....	3.00
959	Pentode, 1.25 v., 0.05 a. fila.....	5.00

MISCELLANEOUS

No.	Description	Amateur Net Price
VR75-30	Voltage Regulator (75 v.).....	\$ 1.25
VR105-30	Voltage Regulator (105 v.).....	1.25
VR150-30	Voltage Regulator (150 v.).....	1.25
1851	High Transconductance Pentode.....	2.10
2050	Gas Tetrode (Max. anode ma. =100).....	3.00
2051	Gas Tetrode (Max. anode ma. =75).....	2.50

